

HAGER & WERKEN

Innovation for Perfection

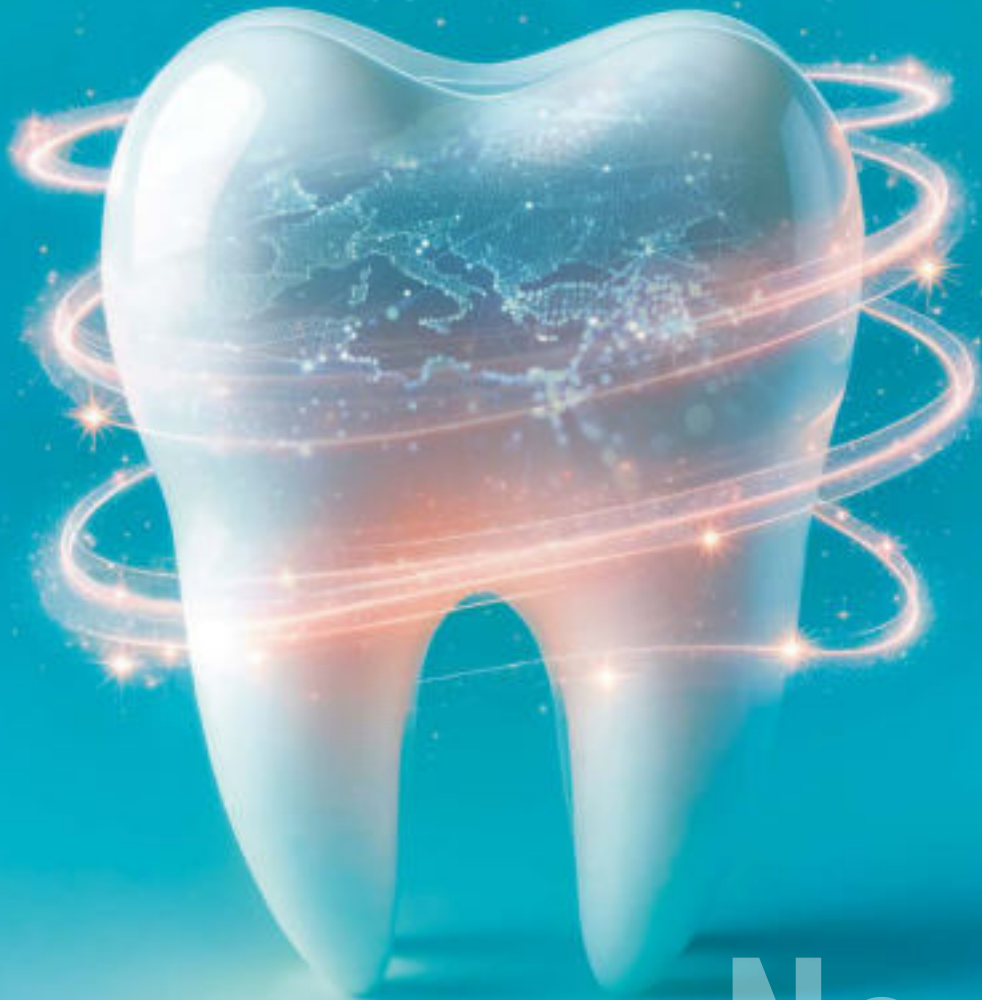

No. 21



BAMBACH®

Mira-2-Ton®



hf Surg®

Miraject®





Airsonic®

X miradent

OUR TEAM WORLDWIDE



Our team in Germany is available:

-  **Mon. – Thu. 08:00 – 17:00**
Fri. 08:00 – 15:30
-  **+49 (203) 99269 + extension number**
-  **Fax: +49 (203) 299283**

Service Export

- Anneli Heyse, a.heyse@hagerwerken.de - 43
- Florentine Fröhling, f.froehling@hagerwerken.de - 45
- Dirk Seelbach, d.seelbach@hagerwerken.de - 47
- Larissa Klein, l.klein@hagerwerken.de - 34

Complaint Management

- technischer-service@hagerwerken.de - 61

European Sales and Marketing Director

- Marcus van Dijk, m.vandijk@hagerwerken.de - 16

European Sales Manager

- Jörg Zensen, j.zensen@hagerwerken.de



Patrick Hager,
President

Michael Hager,
Senior Adviser



Häger & Werken GmbH & Co. KG
Ackerstraße 1, DE-47269 Duisburg
Tel: +49 (203) 99269-0
Fax: +49 (203) 299283
E-Mail: info@hagerwerken.de
Internet: www.hagerwerken.de
General Manager: Patrick Hager



Häger Worldwide, Inc.
441 19TH Street SE
Hickory N.C. 28602, USA
Tel: +001 (828) 624-3300
Fax: +001 (828) 624-3303
E-Mail: contact@hagerworldwide.com
Internet: www.hagerworldwide.com
General Manager: Patrick Rouillard



Häger Australia Pty Ltd
Level6, Wyoming*
175 Macquarie Street
Sydney NSW 2000



Häger Asia
Unit05 7/F, Tower B
New Trade Plaza
6 On Ping Street, Shatin
N.T. Hong Kong



TOO „HAGER EURASIA“
„Dostyk Residence“
Mitina str., bldg. 4, office 904
Almaty, Kazalistan
Tel: +7 777 031 0291
Email: o.seifert@hagerwerken.de
General Manager: Olga Seifert



HAGER PHARMA GmbH
Ackerstraße 1, 47269 Duisburg, Germany
Tel: +49 (203) 99 269 900
Fax: +49 (203) 99 269 999
E-Mail: info@hager-pharma.de
Website: www.hager-pharma.de
General Manager: Klemens Böhm



Our international team

INDEX CHAPTER

01	BIOLINE	4 – 7	09	DEVICES	54 – 61
02	IMPRESSION	8 – 11	10	MIRADENT®	62 – 75
03	APPLICATION / INJECTION	12 – 19	11	MARA® EXPERT	76 – 77
04	DENTAL PRACTICE SUPPLIES	20 – 31	12	FUN & PRACTICAL	78 – 81
05	PROPHYLAXIS	32 – 36	13	LABORATORY	82 – 85
06	ASPIRATION / RUBBER DAM	38 – 45	14	BAMBACH®	86 – 90
07	FILLINGS / ENDODONTICS	46 – 49	15	INDEX PRODUCTS	91
08	PROTECTION / HYGIENE	50 – 53			

BESTSELLER

<p>Miratray® Implant Implant impression tray with patented foil technique</p>  <p>8</p>	<p>Miratray®-Mini For single impressions of crowns and small bridges</p>  <p>9</p>	<p>Miraject® Application canulae</p>  <p>12 – 14</p>
<p>Reso-Pac® Odontologischer Wundschutzverband</p>  <p>17</p>	<p>GapSeal® The key to preventing peri-implantitis</p>  <p>18</p>	<p>OXYSAFE®</p>  <p>19</p>
<p>Mira-2-Ton® Plaque-Disclosing</p>  <p>32/64</p>	<p>Happy Morning® Single-use toothbrush with toothpaste</p>  <p>33/67</p>	<p>paroguard® Patient-friendly mouth rinse</p>  <p>33/68</p>
<p>hf Surg® Touch Kompaktes HF Chirurgiegerät</p>  <p>54</p>	<p>Xylitol Chewing Gum Sugar-free chewing gum with xylitol</p>  <p>62</p>	<p>Bambach Saddle Seat® The Original – For a healthy back</p>  <p>86 – 90</p>



More and more practices are considering sustainable products to be an important environmental contribution. With our new BIOLine series, we now offer dental sustainable alternatives. All BIOLine products are compostable, biodegradable or made of recycled material.



Happy Morning® Bamboo

Single-use toothbrush made of bamboo

- Handle made from 100 % biodegradable, sustainably grown bamboo
- Bamboo acts antibacterial and germ-reducing
- Bristles are impregnated with xylitol toothpaste
- Short head design (2.5 cm)
- Individually, hygienically packed in biodegradable film

Article(s)	Content(s)	REF
Happy Morning Bamboo	40 pcs.	605 426

Bio Dento-Box I:
Height 3 cm



Bio Dento-Box II:
Height 4 cm

Bio Dento-Box®

Solid transport and storage box

- Made of bio-plastic (Terralene 75 %, 25 % Mineral Material)
- For prosthesis, orthodontic works, etc.
- Impact-proof, safe snap lock and small ventilation holes
- Biodegradable

Article(s)	Content(s)	REF
Bio Dento-Box I	12 pcs.	640 020
Bio Dento-Box II	10 pcs.	640 030



W x H x D: 28 x 18 x 1.5 cm

Bio Trays

Single-use trays for dental instruments

- PLA: Polymer of plant origin (derived from corn starch)
- Highly stable product
- Transparent coloring
- Compostable

Article(s)	Content(s)	REF
Bio Trays	100 pcs.	640 010



Size
7 x 8 cm

Bio Mix Mixing Pad

Single-use mixing pads

- Made of bioplastics (made of 75 % Terralene and 25 % mineral charge)
- For impression materials, cements, composites etc.
- Made of paper in combination with Biocartene (bio-based plastic)
- Consisting of 100 sheets, each 0.10 mm thick
- Non-slip base with special plastic-free coating
- Biodegradable

Article(s)	Content(s)	REF
Bio Mix Mixing Pad	6 x 100 sheets	640 011

Bio Apply-Tips®

Fine application tips

- Made partially from wheat straw
- For precise application of liquids and pastes
- Bendable ends for areas that are difficult to access
- Economical use of expensive materials (such as bonding, medication, etc.)
- Acid resistant to bonds and other materials
- Biodegradable



Article(s)	Content(s)	REF
Super fine, 1.5 mm	100 pcs.	640 050
Fine, 1.9 mm	100 pcs.	640 051
Regular, 3.0 mm	100 pcs.	640 052

Super fine

1.5 mm



Fine

1.9 mm



Regular

3.0 mm



Bio Mouse and Bio Keyboard Sleeves

Hygienic sleeves for PC mouse / PC keyboard

- Soft and flexible material
- Biodegradable

Article(s)	Content(s)	REF
Bio Mouse (large)	500 pcs.	640 061
Bio Keyboard (small)	250 pcs.	640 067
Bio Keyboard (large)	250 pcs.	640 066

Size:
large 90 x 160 mm



Size:
small 160 x 550 mm
large 210 x 550 mm



Bio Dapp

Single-use Dappen

- Made of bioplastic (Terralene 75 %, 25 % Mineral Material)
- To mix and prepare dental materials
- Notch to fix on the tray
- Biodegradable

Article(s)	Content(s)	REF
Bio Dapp	200 pcs.	640 015



2-3 ml



Bio Sensor Sleeves

Hygienic protective sleeves for x-ray sensors

- Very soft and tactile material
- Biodegradable

Article(s)	Content(s)	REF
Bio Sensor (small)	500 pcs.	640 070
Bio Sensor (medium)	500 pcs.	640 071

Size:
small 42 x 200 mm
medium 45 x 200 mm





Size: 100 x 280 mm



Bio Cup

Single-use mouth rinse cups

- Made from FSC certified paper
- Leak proof due to PLA coating
- Dispenses easily from cup dispenser due to their rolled lip
- Capacity: 180 ml (6 Oz)
- Compostable

Article(s)	Content(s)	REF
Bio Cup	1,000 pcs.	640 000

Cup Dispenser

Adjustable cup dispenser made of ABS plastic

- Self-adhesive
- Capacity about 50 cups
- Adjustable to 150 ml – 200 ml cups

Article(s)	Content(s)	REF
Cup Dispenser	1 pc.	640 007



Bio Bowl

Kidney trays made from recycled paper

- For storage after treatment
- Compostable

Article(s)	Content(s)	REF
Bio Bowl	50 pcs.	640 040

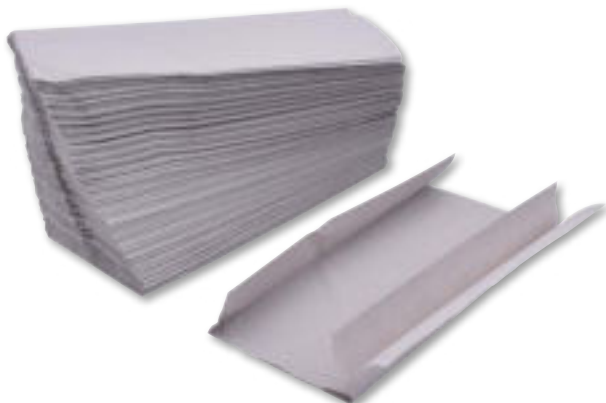

Bio Towel

Recycled paper napkins

- Natural gray, without dyes
- 1-ply, C-fold
- 40 gr/m²
- Compostable
- Folded: 22.6 x 9.1 cm / Unfolded: 33.5 x 22.6 cm

Article(s)	Content(s)	REF
Bio Towel	3.000 pcs.	640 013

Bio Miratray®-Mini

For single impressions of crowns and small bridges

- Easy to slide onto reamed forceps
- Ideal for patients with gag reflex
- Saves impression material



Article(s)	Content(s)	REF
Bio Miratray-Mini	50 pcs.	315 779

Bio Miratray® Partiiell

Partial bioplastic impression trays in three different shape types

- Ideal for patients with gag reflex
- Save impression material



Article(s)	Content(s)	REF
Bio Miratray Partiiell, right, PR	100 pcs.	641 148
Bio Miratray Partiiell, left, PL	100 pcs.	641 146
Bio Miratray Partiiell, center, PM	100 pcs.	641 147
Bio Miratray Partiiell, assortment II	100 pcs.	641 151

Bio Miratray®

Single-use bioplastic impression tray

- Good retention of the impression material thanks to retention baskets
- Easy to write on with a felt-tip pen
- Available as a full tray in three sizes (S, M, L)



Article(s)	Content(s)	REF
Bio Miratray, UJ, S1, small	50 pcs.	641 140
Bio Miratray, UJ, S2, medium	50 pcs.	641 141
Bio Miratray, UJ, S3, large	50 pcs.	641 142
Bio Miratray, LJ, I1, small	50 pcs.	641 143
Bio Miratray, LJ, I2, medium	50 pcs.	641 144
Bio Miratray, LJ, I3, large	50 pcs.	641 145
Bio Miratray assortment I	50 pcs.	641 149

Pelotte Bio

Suction cannula with valve

- Double tips: S-shape + S-shape
- Ventilated to prevent blockage
- No phthalates, no latex
- Made from environmentally friendly Green PE
- Length: 145 mm, ø 11 mm
- Optional adapter 11 to 16 mm



Article(s)	Content(s)	REF
Pelotte Bio	100 pcs.	640 090

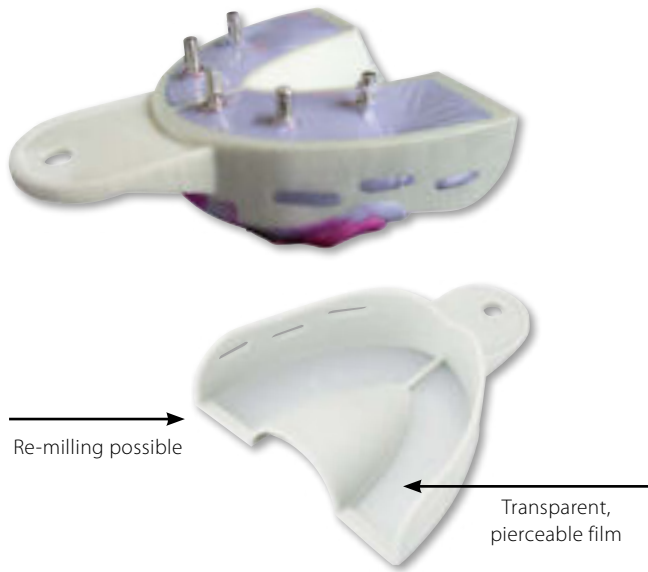

Miratray® Implant

Implant impression tray with patented foil technique

- Perfect, open implant impression
- Impression in just one session without additional laboratory costs
- Controlled and safe impression taking with the impression posts clearly visible
- Clean working environment due to the precise sealing of the foil to the impression posts
- No overflowing impression material
- Customizable, user-friendly, cost-effective and hassle free
- Suitable for all implant impression materials and implant systems

"I use Miratray Implant in my practice because it is no longer necessary to have an individual tray made in the laboratory = time saving (appointment) and cost saving for the patient".
Mrs. Petra Weidenmüller, Germany



Often requires laborious adaptation



Perfect fit

Article(s)	Size	Content(s)	REF
Intro Kit 6 x 1 pc. (Upper Jaw (UJ) / Lower Jaw (LJ) small, medium, large)		6 pcs.	101 250
UJ, S1	small	6 pcs.	101 251
UJ, S2	medium	6 pcs.	101 252
UJ, S3	large	6 pcs.	101 253
LJ, I1	small	6 pcs.	101 254
LJ, I2	medium	6 pcs.	101 255
LJ, I3	large	6 pcs.	101 256



Miratray® 3 in 1

3 work steps in one – impression, counter impression, bite registration

- Time saving: A double impression is taken (upper jaw and lower jaw) in just one step
- Material savings: Partial impression with direct correlation of the occlusion
- Patient-friendly: Faster and less gag reflex
- Sheer, tearproof net material
- Dimensionally stable due to strengthened sides, color-coded



Article(s)	Content(s)	REF
Posterior, green	36 pcs.	101 270
Quadrant, yellow	36 pcs.	101 271
Anterior, purple	32 pcs.	101 272
Full Arch, blue	28 pcs.	101 273



IMPRESSION

Miratray®-Mini

For single impressions of crowns and small bridges

- Excellent for patients, avoids gag reflex
- Cost effective disposable plastic tray
- Saves impression material
- Can easily be slid onto corrugated tweezers

Article(s)	Content(s)	REF
Miratray-Mini	50 pcs.	101 102



Miratray® Partiiell

Partial plastic impression tray in three shapes

- Ideal for patients with gag reflex
- Saves impression material

Article(s)	Content(s)	REF
Bag, right PR	12 pcs.	101 178
Box, right PR	100 pcs.	101 148
Bag, left PL	12 pcs.	101 176
Box, left PL	100 pcs.	101 146
Bag, middle PM	12 pcs.	101 177
Box, middle PM	100 pcs.	101 147
Assortment II, all 3 shapes assorted	100 pcs.	101 151

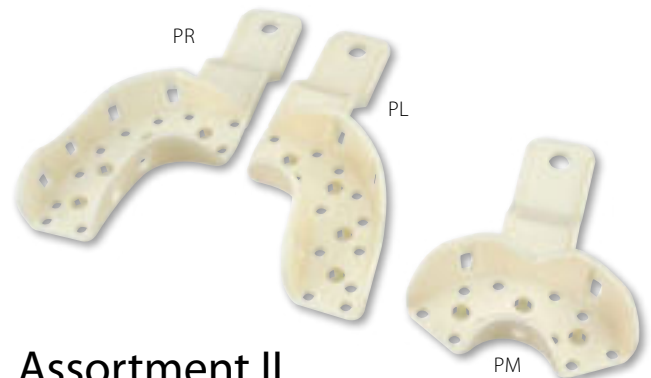

Assortment II

100 partial trays in three shapes, assorted:
 Shape: PL PR PM
 Quantity: 33 33 34

Miratray®

Single-use impression tray made of white plastic

- Cost effective and solid
- Excellent retention of the impression material by special "retention baskets"
- Practical, can be labelled with felt-tip pen
- Complete tray available in three sizes (s, m, l)

Article(s)	Size	Content(s)	REF
UJ, S1	small	50 pcs.	101 140
UJ, S2	medium	50 pcs.	101 141
UJ, S3	large	50 pcs.	101 142
LJ, I1	small	50 pcs.	101 143
LJ, I2	medium	50 pcs.	101 144
LJ, I3	large	50 pcs.	101 145
UJ, S1	small	12 pcs.	101 170
UJ, S2	medium	12 pcs.	101 171
UJ, S3	large	12 pcs.	101 172
LJ, I1	small	12 pcs.	101 173
LJ, I2	medium	12 pcs.	101 174
LJ, I3	large	12 pcs.	101 175
Assortment I, assorted		50 pcs.	101 149

S = Superior, I = Inferior, UJ = Upper Jaw, LJ = Lower Jaw

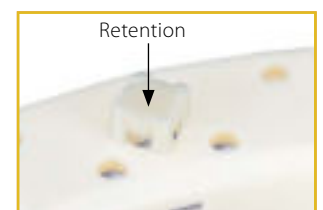

Assortment I

50 complete/partial trays in nine designs, assorted:
 Shape: I2 S2 S3 S1 I1 I3 PL PR PM
 Quantity: 10 10 5 5 5 5 3 3 4



Miratray® Spray

Adhesive spray for alginates

- An ideal spray adhesive for all dental impression trays
- Impressions adhere much better to the metal or plastic impression tray
- For use with alginates only.

Article(s)	Content(s)	REF
Miratray Spray	200 ml	554 210

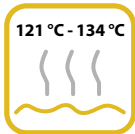

Autoclavable



Algilock®

Extremely durable impression tray

- "Retention rims" hold the impression material without adhesives
- For dentulous jaws
- High-quality, corrosion-resistant stainless steel
- Autoclavable
- On request, Algilock is available for maxilla and mandible as:
 - Algilock partial (perforated/non-perforated)
 - Algilock pedo (orthodontology)
 - Algilock edentulous (perforated)

Article(s)	Size	USA	REF
UJ, BS 5	xx-large	U11	101 006
UJ, BS 3	x-large	U12	101 004
UJ, BS 2A	large	U13	101 042
UJ, BS 2	medium	U14	101 003
UJ, BS 1	small	U15	101 002
LJ, BI 5	xx-large	L11	101 011
LJ, BI 3	x-large	L12	101 009
LJ, BI 2A	large	L13	101 043
LJ, BI 2	medium	L14	101 008
LJ, BI 1	small	L15	101 007
Set with 10 trays (5 UJ, 5 LJ)			101 001

BS = Dentulous Superior, BI = Dentulous Inferior,
UJ = Upper Jaw, LJ = Lower Jaw

Algilock® Perforated

Perforated impression tray

- For dentulous jaws
- High-quality corrosion-resistant stainless steel
- Durable, high dimensional stability
- Retention rims hold impression material in place – no adhesive required
- Laser-welded handles and palatine ridge
- Autoclavable without loss of quality

Article(s)	Size	USA	REF
UJ, PS 6	x-large	7	101 036
UJ, PS 5	large	5	101 034
UJ, PS 4	medium	4	101 033
UJ, PS 3	small	1	101 032
LJ, PI 6	x-large	24	101 041
LJ, PI 5	large	22	101 039
LJ, PI 4	medium	21	101 038
LJ, PI 3	small	20	101 037
with 8 trays (4 UJ, 4 LJ)			101 031

PS = Perforated Superior PI = Perforated Inferior,
UJ = Upper Jaw, LJ = Lower Jaw



IMPRESSION

Algiloid®

Highly precise hydro impression material

- Favorable alternative to silicone impressions
- The tray remains in the mouth for only approx. 3 min.
- Easy and quick handling
- Combines the advantages of agar hydrocolloid with those of alginate

Highly precise, cost effective and time-saving impressions with the Algiloid System

The Algiloid system consists of algiloid hydro material as "light body" and customary alginate as "heavy body".

Article(s)	REF
Box with 48 cylinder ampoules	101 401
Cylinder ampoule syringe III, incl. 2 attachments	101 405



Algilock® Cleaner Plus

Alginate remover

- Cleaning in dipping bath without mechanical impact, no ultrasound, no scratching
- Decomposes the organic structure of the impression material, no aggressive or caustic effect, corrosion resistant
- Impression trays do not tarnish even after multiple cleanings
- Bio-degradable and pH-neutral, phosphate-free, pleasant smell
- For approx. 500 trays

Easily removes plaster and alginates from impression trays, instruments and spatulas. No laborious and time-consuming cleaning, simply add 50 g to 1 l of warm water and leave for approx. 15 – 30 minutes. May also be used in an ultrasonic unit. Not suitable for aluminum trays.

Article(s)	Content(s)	REF
Algilock Cleaner Plus	1000 g	554 104



Occlu® Spray Plus





Premium green occlusion spray

- To mark contact points by spraying directly onto the occlusal surfaces or inside of crowns
- Micro powder layer for highest accuracy
- With food coloring
- Powder layer can easily be removed with water





Article(s)	Content(s)	REF
Aerosol spray, green	75 ml	554 205
Aerosol spray, green	50 ml	554 211







Standard

- Miraject P (Carpule)**
REF 254 206
0.8 x 25 mm/21G
 21G
- Miraject P Super (Carpule)**
REF 254 207
0.9 x 32 mm/20G
 20G
- Miraject PL Super (Luer)**
REF 254 214
0.9 x 22 mm/20G
 20G
- Miraject Endo Luer**
REF 254 222
0.3 x 40 mm/30G
 30G
- Miraject Endo Luer**
REF 254 215
0.5 x 40 mm/25G
 25G

Endotec Luer







- Miraject Endotec Luer**
REF 254 216
0.8 x 25 mm/21G
 21G
- Miraject Endotec Luer**
REF 254 217
0.6 x 25 mm/23G
 23G
- Miraject Endotec Luer**
REF 254 218
0.5 x 25 mm/25G
 25G
- Miraject Endotec Luer**
REF 254 228
0.4 x 25 mm/27G
 27G
- Miraject Endotec Luer**
REF 254 219
0.3 x 25 mm/30G
 30G

Endotec Luer Duo





- Miraject Endotec Duo**
REF 254 230
0.6 x 25 mm/23G
 23G
- Miraject Endotec Duo**
REF 254 231
0.5 x 25 mm/25G
 25G
- Miraject Endotec Duo**
REF 254 232
0.4 x 25 mm/27G
 27G
- Miraject Endotec Duo**
REF 254 233
0.3 x 25 mm/30G
 30G

INJECTION

Carpule

- Miraject 17/42**
REF 254 200
0.5 x 35 mm
 25G
- Miraject 17/23**
REF 254 201
0.5 x 21 mm
 25G
- Miraject 30/42**
REF 254 202
0.4 x 35 mm
 27G
- Miraject 30/23**
REF 254 203
0.4 x 21 mm
 27G
- Miraject 40/23**
REF 254 204
0.3 x 21 mm
 30G
- Miraject 40/10**
REF 254 205
0.3 x 10 mm
 30G

Luer

- Miraject Luer 17/42**
REF 254 210
0.5 x 42 mm
 25G
- Miraject Luer 17/23**
REF 254 211
0.5 x 23 mm
 25G
- Miraject Luer 30/42**
REF 254 212
0.4 x 42 mm
 27G
- Miraject Luer 30/23**
REF 254 213
0.4 x 23 mm
 27G

APPLICATION

Miraject® P / P Super

Cannulas for paste-like materials

- Blunt, bendable and individually sterile packed
- For cylinder ampoules
- Color-coded

Pack with 100 pieces

Article(s)	∅	Gauge	Length	REF
Miraject P	0.8 mm	21	25 mm	254 206
Miraject P Super	0.9 mm	20	32 mm	254 207

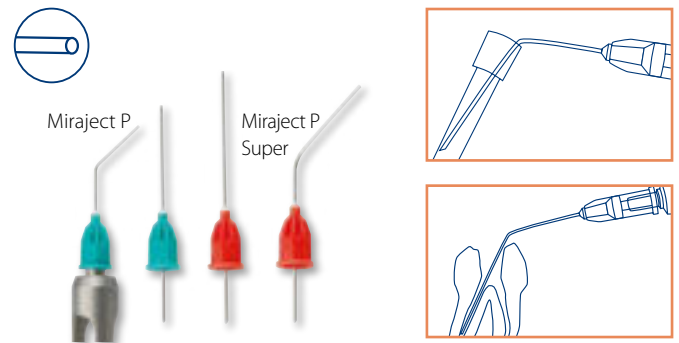

Miraject® PL Super

Short blunt Luer application cannulas

- For application of liquids, gels and for rinsing wider root canals
- Sterile packed
- Bendable
- For syringes with Luer tip

Pack with 100 pieces

Article(s)	∅	Gauge	Length	REF
Miraject PL Super	0.9 mm	20	22 mm	254 214



Miraject® Endo Luer

Blunt, flexible cannulas for use in endodontics

- Application of liquids and pastes into the root canal
- Finest controllable measures
- In two sizes: 0.3 mm (30 gauge) and 0.5 mm (25 gauge)
- Easy-to-insert into the root canal
- For syringes with Luer tip
- Color-coded

Pack with 100 pieces

Article(s)	∅	Gauge	Length	REF
Miraject Endo Luer, fine	0.3 mm	30	40 mm	254 222
Miraject Endo Luer, medium	0.5 mm	25	40 mm	254 215



Miraject® Endotec Luer

Special irrigation cannulas with lateral opening

- Extra gentle, effective rinsing process
- Lateral opening avoids pressure on the apex
- Round canula end – low perforation risk
- Also ideal for gentle rinsing of periodontal pockets
- Sterile packed
- For syringes with Luer tip
- Sterile packed and color-coded

Pack with 25 pieces

Article(s)	∅	Gauge	Length	REF
Endotec Luer	0.8 mm	21	25 mm	254 216
Endotec Luer	0.6 mm	23	25 mm	254 217
Endotec Luer	0.5 mm	25	25 mm	254 218
Endotec Luer	0.4 mm	27	25 mm	254 228
Endotec Luer	0.3 mm	30	25 mm	254 219





Miraject® Endotec Duo

Special cannulas with two lateral openings

- Extra gentle, effective rinsing process
- Two lateral openings avoid pressure on the apex
- Round canula end – low perforation risk
- Also ideal for gentle rinsing of periodontal pockets
- Sterile packed
- For syringes with Luer tip
- Color-coded

Pack with 25 pieces

Article(s)	Ø	Gauge	Length	REF
Endotec Duo	● 0.6 mm	23	25 mm	254 230
Endotec Duo	● 0.5 mm	25	25 mm	254 231
Endotec Duo	● 0.4 mm	27	25 mm	254 232
Endotec Duo	● 0.3 mm	30	25 mm	254 233



Miraject® Luer

Injection cannula with plastic Luer cone

- For injection solutions from an ampoule
- For any conventional disposable syringe
- Individually and sterile packed
- Color-coded

Pack with 100 pieces

Article(s)	Ø	Gauge	Length	REF
17/42	● 0.5 mm	25	42 mm	254 210
17/23	● 0.5 mm	25	23 mm	254 211
30/42	● 0.4 mm	27	42 mm	254 212
30/23	● 0.4 mm	27	23 mm	254 213



Miraject®

THE injection cannula on the dental market

- The classic disposable cannula for cylinder ampoules
- Has been the hallmark of quality for more than 60 years – over 400 million Miraject cannulas meeting highest quality standards
- Manufactured under strictest quality controls
- Meets the highest requirements of injection hygiene, every needle is equipped with a sterility control seal
- Triple lancet cut – almost painless
- Injection mark – orientation
- Silicone coating – ideal gliding behavior

Pack with 100 pieces

Article(s)	Ø	Gauge	Length	REF
17/42	● 0.5 mm	25	35 mm	254 200
17/23	● 0.5 mm	25	21 mm	254 201
30/42	● 0.4 mm	27	35 mm	254 202
30/23	● 0.4 mm	27	21 mm	254 203
40/23	● 0.3 mm	30	21 mm	254 204

Short cannula for intraligamentary anaesthesia (not suitable for the Miramatic system):

40/10	● 0.3 mm	30	10 mm	254 205
-------	----------	----	-------	---------

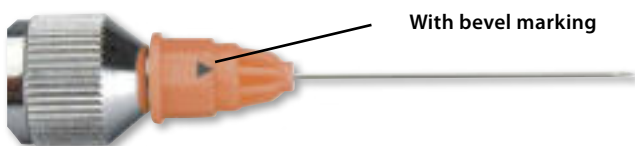

With bevel marking

Miraject® Flexi Tip

Application tips with Luer syringes

- Blunt plastic needle tip
- Very flexible and dimensionally stable
- For exact application and dosing of highly fluid pastes and liquids
- Single-use only

Article(s)	Content(s)	REF
Miraject Flexi Tip 21G, medium, ø 0.6 – 0.8 mm x 24 mm	25 pcs.	254 241
Miraject Flexi Tip 27G, fine, ø 0.2 – 0.4 mm x 20 mm	25 pcs.	254 242



Miramatic® Holder Plus

Solid safety stand for injection syringes and irrigation cannulas

- No risk of injury from needles
- One-hand re-capping reduces injury risk
- Syringe sits upright in its own protective cover
- Fixing clamp holds the protective cover tightly
- Stainless steel, approx. 240 g

Article(s)	REF
Miramatic Holder Plus	355 466
Miramatic Holder	355 465



Miramatic® Holder



- Syringe stands hygienically in its own protective cap
- Very stable due to 200 g net weight
- Autoclavable, chrome-plated metal stand

Safety-Box

Disposal boxes

- With automatic lid, that opens at the touch of a button
- Disposal of used cannulas and other blood- and saliva-contaminated products such as scalpels, disposable syringes, etc.
- Absolutely safe storage due to firmly fixed lid with safety lock
- The opening can be enlarged gradually by pushing out the flap
- Table fixing device for firm placement of the box

Article(s)	REF
5 boxes, 1 table fixing device	355 491
Box, separately	355 490
Table fixing device, separately	355 472



Content: 2.1 l



Safety System



✓ Table fixing device



Apply-Tips®

Fine application tips

- For precise application of liquids and pastes
- Bendable ends for hard-to-access areas
- Economic use of expensive materials (such as bondings, medicaments, etc.)
- Acid-resistant against bonding and other materials
- Hygienic dispenser box for single removal
- Available in three sizes

Article(s)	Content(s)	REF
Medium (regular), blue handle	100 pcs.	605 510
Medium (regular), blue handle	5 x 100 pcs.	605 511
Fine, white handle	100 pcs.	605 512
Fine, white handle	5 x 100 pcs.	605 513
Conical, green handle	100 pcs.	605 514
Conical, green handle	5 x 100 pcs.	605 515
Dispenser	1 pc.	355 155



Pick up Stick

Adhesive application aid

- Bendable stick with adhesive wax tip
- Ideal for quick and precise pick-up of crowns, inlays, veneers

Article(s)	Content(s)	REF
Pick up Stick	30 pcs.	605 423



Twin-Pipette

Pipette with two chambers

- For measuring out the exact dosage of drops or for thorough rinsing
- Front chamber = drops, rear chamber = rinsing
- Pipette end can be cut off for increased flow, e.g. for subgingival rinsing

Article(s)	Content(s)	REF
Twin-Pipette	100 pcs.	605 352

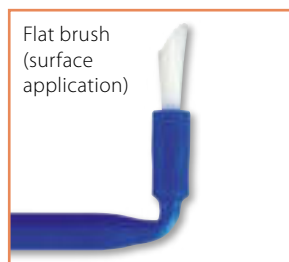
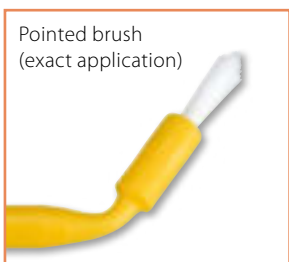

Mirabrush®

Bendable application brush

- One-piece disposable brush
- Bendable: can be bended into any angle
- Time-saving: no changing of brushes
- Safe: no danger of cross infection

Dispenser pack

Article(s)	Content(s)	REF
Regular 10 cm, yellow / pointed	100 pcs.	605 460
Regular 10 cm, blue / flat	100 pcs.	605 461

APPLICATION

Reso-Pac®

Odontological wound protection dressing

- Very good adhesive properties
- For direct application to wounds and sutures
- Keeps bacteria out and promotes healing
- Ideal wound and suture protection in implantology, periodontology, post-extractions, orthodontics, and prosthetics
- Used to cover applied medications
- Remains soft – Tasteless – Odorless

Article(s)	Content(s)	REF
Reso-Pac	25 g	155 011
Reso-Pac value pack	5 x 25 g	155 010



Before



After



Myzotect®-Tincture

Myrrhe-Benzoin-Aloe-Tinkture

- After periodontal treatments and dental procedures
- Myrrh (tissue-strengthening and nurturing) helps with the after-effects of tooth and gum treatments.
- Benzoin and aloe help nourish and strengthen the oral mucosa
- Use without antibiotics or corticosteroids
- Does not sting after application and adheres to the mucosa for a long time due to its syrupy consistency
- Lasts for over 100 applications

Article(s)	Content(s)	REF
Myzotect-Tincture (brush included)	5 ml	155 008
Myzotect-Tincture	50 ml	155 005

TIP: For home use by the patient

Myzotect-Tincture	10 x 5 ml	155 007
-------------------	-----------	---------





Peri-implantitis

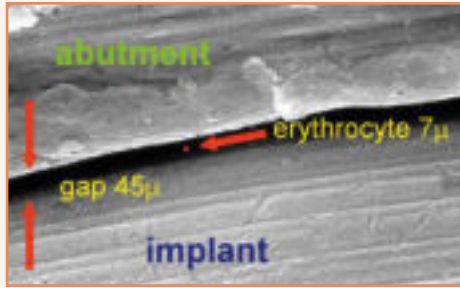

Gap between abutment and implant



Application of the GapSeal sealant

Clinically proven for over 25 years

Twist mechanism →

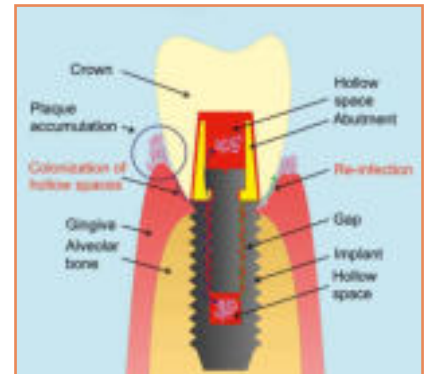

Gaps and hollow spaces with microbial colonization in a compound implant

GapSeal®

The key to preventing peri-implantitis

- Germ-tight in gaps and cavities of multi-component implants
- Long-lasting hermetic protection
- Prevents the negative effects of microleakage
- Tissue friendly, does not harden
- Highly viscous, transparent material (silicone matrix)
- One tip for approximately 3 implants

Article(s)	REF
GapSeal Set (applicator with 10 tips)	152 041
GapSeal Refill Pack (10 tips à 0.06 ml)	152 040
Applicator separately	152 042



GapSeal sealing immediately after insertion



GapSeal superstructure sealing in implant-supported bar abutments

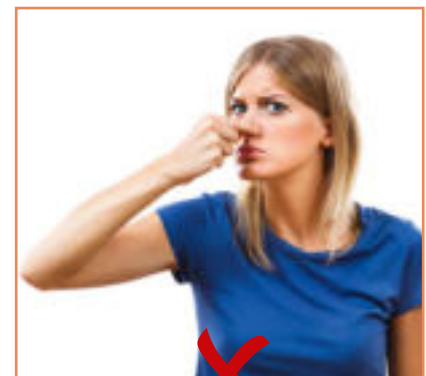

Implant opened? Does it stink?

Bad smell indicates bacterial infiltration

> GapSeal protects against bacteria, viruses and fungi

SIMPLY GOOD – TWICE AS EFFECTIVE

Active oxygen booster for periodontitis and peri-implantitis

-  Rapid pocket depth reduction
-  Destroys harmful anaerobic bacteria
-  Accelerated wound healing
-  No antibiotics, no CHX
-  Excellent clinical results
-  Reduces the need for periodontal surgery
-  Delegable
-  For use in conjunction with anti-infective therapy (AIT) and supportive periodontal therapy (SPT)



Application



Patient continues treatment at home



Patientensituation nach erfolgter Therapie mittels Metronidazol, CHX Chips, aPDT und anderen Maßnahmen nach dem 3. Recall



Application of the OXYSAFE gel in situ



Patient situation 3 weeks after the start of oxygen treatment with OXYSAFE Professional

OXYSAFE® Professional

Article(s)	Content(s)	REF
OXYSAFE Intro Kit	3 x 1 ml Gel, 3 x 250 ml Liquid + 3 x application cannulas	155 040
OXYSAFE Gel	3 syringes à 1 ml (refill)	155 041
OXYSAFE Liquid	250 ml	155 042

User testimonials

- Dani Müller, DCP: "Easy to use, killing anaerobic bacteria with oxygen."
- Natascha Thiem, DCP: "A great enrichment as the handling and use are simple and very effective."
- Christina Eilers, DH: "I find OXYSAFE Professional a good addition to PA therapy since it supports wound healing."



Cleaning a pair of scissors



Cleaning a scaler



Serves as cushion for endodontic needles



Fit-N-Swipe Clean

Adhesive cleaning pads for clean instruments

- Unique microfiber with high retention capacity
- Safe and convenient storage for endodontic needles

Article(s)	Content(s)	REF
Fit-N-Swipe Clean, white	50 pcs.	605 251

Ideal for autoclave sterilization



Microfiber structure



User testimonials

Bettina Drewes, DH: "I think Fit-N-Swipe is very good. It simplifies the work in prophylaxis, where usually no assistance is available."

Melanie Graf, DCP: "Absolutely great! They're very easy to use and it's a neat thing. Glove on, swipe on, fit for the next treatment – then, together with the glove, into the trash in no time at all!"



Wet, fogged mouth mirror

Multi-layer structural fiber

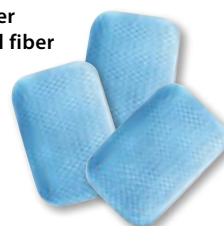

Fit-N-Swipe Dry

Adhesive drying pads for mouth mirrors

- Unique multi-layer fiber
- Removes even greasy or oily contaminants without leaving streaks

Article(s)	Content(s)	REF
Fit-N-Swipe Dry, blue	50 pcs.	605 252



Simply wipe off on the pad



Crystal clear mouth mirror

Miraclip

Napkin holders

- Made of autoclavable rubber material with stainless steel clips

Article(s)	Content(s)	REF
Miraclip, blue	1 pc.	605 240
Miraclip, yellow	1 pc.	605 241
Miraclip, violet	1 pc.	605 242
Miraclip, white	1 pc.	605 243
Set of 4, 1 of each color	4 pcs.	605 228

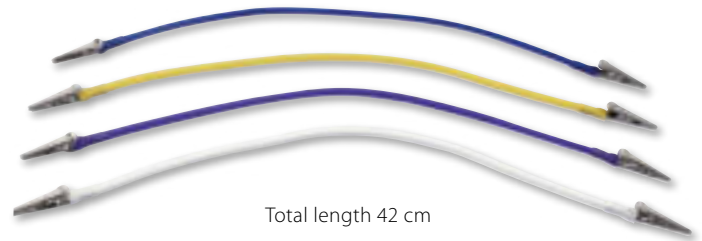

Total length 42 cm

Fit-N-Fix

Single-use, hygienic napkin holder

- Easy to use – remove protective foil and stick to paper napkin
- Stretch material made of soft silk-like fiber
- Works with all any paper napkin
- Easy to use, disposable with the napkin
- Available in two floral designs

Article(s)	Content(s)	REF
Fit-N-Fix, blue	200 pcs.	605 249
Fit-N-Fix, pink	200 pcs.	605 250



Length 38 cm

Cotton-Clip

Cotton roll holder

- Holds cotton rolls securely in place for a dry work area
- Made of lightweight plastic

Article(s)	Content(s)	REF
Cotton-Clip, plastic	100 pcs.	605 350



Cottoroll

Cotton roll dispenser

- Hygienic, dry storage
- Quick and easy to access – simply open the drawer
- Drawer refills automatically
- Convenient top-loading function
- Stable, nonslip

Article(s)	REF
Cottoroll	355 132





Cold-Bag

Cold compress for pain relief

- Immediate activation, cools for approx. 30 min. (at 4 °C)
- Effective pain reduction
- Reduces hematomas and swellings
- Patented technology
- Not harmful to the environment

Article(s)	Content(s)	REF
Cold-Bag compresses	10 pcs.	605 501



Miracold® Plus

Cold spray

- Approx. -50 °C at the application canula (plastic)
- Orange flavor
- For vitality testing of devital teeth

Article(s)	Content(s)	REF
Miracold Plus	200 ml	554 213



Occlu® Spray Plus

High-quality, green occlusion spray

- For marking contact points by spraying directly onto the occlusal surfaces occlusal surfaces or the inside of crowns
- Micro powder coating for maximum accuracy
- Contains food coloring
- Powder layer can be easily removed with water

Article(s)	Content(s)	REF
Occlu Spray Plus, green	75 ml	554 205
Occlu Spray Plus, green	50 ml	554 211



Protho Clean®

Cleaning and high-gloss polishing of prosthetic work

- Aesthetically enhances the presentation of your prosthetic work
- Removes polish and monomer residues from dentures
- Simply spray on, allow to soak in and wipe off with a soft cloth
- Pleasant mint flavor

Article(s)	Content(s)	REF
Protho Clean	75 ml	554 220

Spandex®

Cheek and lip retractor

- For a clear view and a clear working field
- Ideal for treatment in the anterior region
- Made of non-reflective plastic (also for photos)
- Autoclavable



Article(s)	Content(s)	REF
Spandex regular	2 pcs.	605 454
Spandex mini (children)	2 pcs.	605 455

Spandex®-Vertical

Lip retractor

- Opens the patient's mouth vertically
- For working on the gingival margin of anterior teeth
- Autoclavable

Article(s)	Content(s)	REF
Spandex-Vertical (2x medium, 2x small)	4 pcs.	605 211



Mirahold®

One-sided cheek retractor

- Long handle for a clear working area
- Useful, e.g. for injections
- Comfortable for the patient
- Autoclavable

Article(s)	Content(s)	REF
Mirahold regular	2 pcs.	605 450
Mirahold Bambino	2 pcs.	605 451



Mirahold®-Block

Elastic bite blocks for mouth opening

- Plastic block to keep the mouth open reliably
- The set includes a special cheek retractor
- Ideal for longer treatments and anxious patients
- Autoclavable

Article(s)	REF
Mirahold-Block Set with 12 bite blocks, 6 small and large each and 2 cheek retractors	605 210
Intro set with 6 bite blocks, 3 small and large each and 1 cheek retractor	605 238
Mini set with 3 bite blocks (small)	605 220
Cheek retractor separately	605 239





Brillant

Single-use mouth mirror made of plastic

- Each mirror protected with foil and single packed, 100 pieces
- Available in two sizes

Article(s)	Content(s)	REF
Size 4, white, ø 19 mm	100 pcs.	605 400
Size 5, white, ø 23 mm	100 pcs.	605 399

ø 19 mm

ø 23 mm



Brillant Anti-Fog

Single-use anti-fog mouth mirror made of plastic

- With anti-fog coating
- Flat, angled mirror head for access to all areas in the oral cavity
- Ergonomic finger-grip handle
- Each mirror protected with peel off foil and single packed

Article(s)	Content(s)	REF
Size 4, white, ø 19 mm	50 pcs.	605 416
Size 4, blue transparent, ø 19 mm	50 pcs.	605 417

ø 19 mm



Mirodent

Single-use anti-fog mouth mirror made of plastic

- Handle with interchangeable mirror – reduces waste

Article(s)	REF
Size 4, ø 19 mm, 100 mirrors + 4 handles (one-ended)	605 404
Mirodent, handle (one-ended)	605 405



Brillant Kids

Dental mirror

- With anti-fog coating
- Each mirror is individually wrapped and protected with foil
- Removable children's design

Article(s)	Content(s)	REF
Size 4, assorted, ø 19 mm	20 pcs.	605 495

ø 19 mm

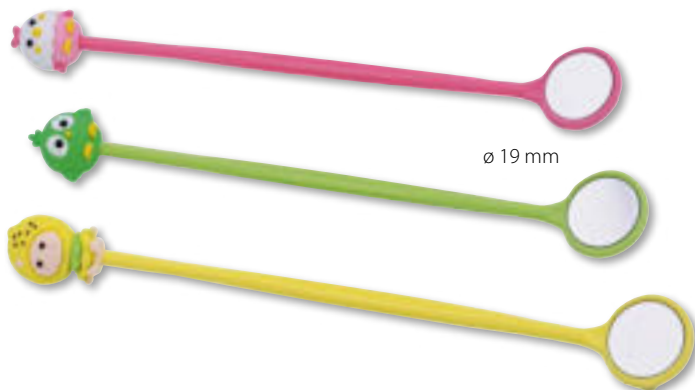

Variator®-Kit

Sterile treatment set

- Includes mouth mirror, tweezers and probe
- Large spatula for mixing cement and filling materials
- Ball head and Heidemann spatula for tamping
- Convenient for home visits, high-risk patients and emergencies
- All three instruments are sterile and blister-packed in one package

Article(s)	Content(s)	REF
Variator-Kit Set	10 Sets	355 441



Reflect-Rhod

Rhodium-coated metal mouth mirror

- Ideal for distortion-free intra-oral photos
- Extensive rhodium coating on one side
- Sturdy, durable
- With detachable silicone handle
- Autoclavable in the provided fabric bag
- Available in three sizes

Article(s)	REF
Set with three mirrors No. 1 – 3	355 480
No. 1, separately (40 x 163 mm)	355 481
No. 2, separately (69 x 163 mm)	355 482
No. 3, separately (79 x 163 mm)	355 483

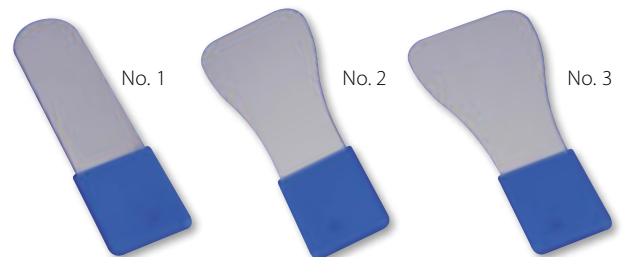
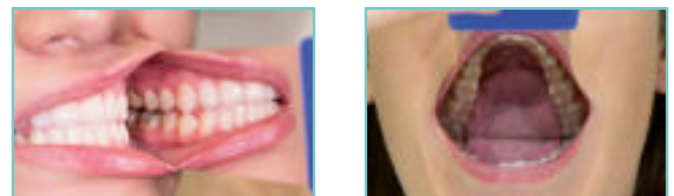

Membranbox

Transport and storage box with inner membranes

- With two elastic, transparent membranes
- Long durability due to high-quality material
- For single crowns, inlays etc.
- Stackable

Article(s)	REF
Small – for single crowns, inlays, etc. (12 boxes)	304 603
Medium – for bridges, partial dentures, attachments, etc.	304 602
XXL – for two models	304 605



Small (W x H x D):
4 x 1.9 x 4 cm



XXL (W x H x D):
19.2 x 4.8 x 9.2 cm



Medium (W x H x D):
8.5 x 2.2 x 9 cm





Protho® Box home

Denture Box

- For safe and thorough cleaning
- With removable sieve
- Recommended for dentures, braces and aligners

Article(s)	Content(s)	REF
Protho Box home, glittery blue	1 pc.	630 270



Dento-Box I: height 2.5

Dento-Box® I + II

Solid transport and storage boxes

- For prothesis, orthodontic works, retainer, etc.
- Impact-proof, safe snap lock and small ventilation holes
- Can be customized with your logo
- Available in two sizes

Article(s)	Content(s)	REF
Dento-Box I, white	○ 12 pcs.	355 148
Dento-Box I, blue	● 12 pcs.	355 149
Dento-Box I, pink	● 12 pcs.	355 150
Dento-Box I, light green	● 12 pcs.	355 151
Dento-Box I, violet	● 12 pcs.	355 152
Dento-Box I, glittery silver	● 12 pcs.	355 153
Dento-Box I, glittery, assorted	● ● ● ● ● ● 6 x 2 pcs.	355 156
Dento-Box II, white	○ 10 pcs.	355 141
Dento-Box II, blue	● 10 pcs.	355 142
Dento-Box II, pink	● 10 pcs.	355 143



Dento-Box II: height 4 cm

BD-Steribox

Container for disinfection

- Useful for small parts, such as burs, diamonds, etc.
- With opening in the lid
- With removable sieve to rinse the content
- Both versions are autoclavable
- Dimensions: Plastic: Total height approx. 12 cm, o approx. 8 cm
Metal: Total height approx. 5 cm, o approx. 9 cm

Article(s)	REF
BD-Steribox plastic	355 139
BD-Steribox metal	355 138



Liftbox

Disinfection box for instruments

- By closing the cover, the filled tray submerges into the disinfectant
- Tray with swivel handle for easy handling
- No direct skin contact with aggressive disinfectants
- Acid-resistant plastic
- Container content: approx. 1.5 l

Article(s)	REF
Liftbox	355 140



Dimensions: ca. 26 x 8.5 x 12 cm

Clip-Clap Strainer RS

Stainless steel strainer

- Convenient to hang in the ultrasonic bath
- For safe scalding of delicate small parts
- Diameter of ball-shaped strainer 45 mm

Article(s)	REF
Clip-Clap Strainer RS	304 140



Dosing Bottle

Transparent squeeze bottles

- With fine jet tip and delivering tube
- For fine dosing of liquids
- Available in two sizes

Article(s)	REF
Dosing Bottle, 250 ml	304 405
Dosing Bottle, 500 ml	304 406



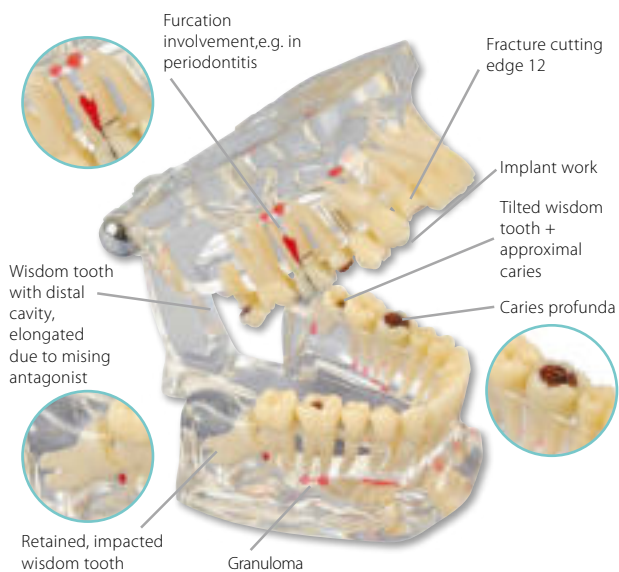

Study Model Transparent De Luxe

Demonstration model adult with tooth diseases

- Visualization of various dental defects, progression of carious defects
- Additionally with malpositioned wisdom teeth in the lower jaw
- Multiple examples of inflamed roots
- Illustration of implant work with abutment
- Teeth cannot be removed
- Scale 1:1



Study Model Transparent Plus

- Visualization of various tooth defects and courses of carious defects
- Teeth not removable, scale 1:1

Article(s)	REF
Study Model Transparent Plus	355 640
Study Model Transparent De Luxe	355 642



Study Model Transparent

High-quality transparent demonstration model

- All 32 teeth can be removed from the alveole
- Well visible root anatomy
- Made of clear, durable plastic
- Scale 1:1

Article(s)	REF
Study Model Transparent	355 641



Mira-Duo

Double-sided patient mirror

- Front 1:1, back double magnification 1:2
- 13 cm diameter
- Can be used as a handheld or standing mirror
- Ideal for checking

Article(s)	REF
Mira-Duo	605 682



McTooth Mirror

Molar-shaped pop-up mirror

- For prophylaxis in children and adults
- Size approx. 17 x 14 cm

Article(s)	REF
McTooth Mirror	707 094

Toothbrushing Model

Enlarged demonstration model

- To demonstrate proper brushing technique
- Includes oversized toothbrush
- Ideal motivation for children



Article(s)	REF
Model incl. super-brush	355 636
Super-brush separately	355 637

Study Model Transparent Child

Demonstration model Child

- Very clear illustration of deciduous and permanent teeth
- Maxilla and mandible with ten deciduous teeth
- With broken deciduous front tooth with root disease
- Scale 1:1

Article(s)	REF
Study Model Transparent Child	355 643
Study Model Transparent Child de Luxe (without tooth decay, not illustrated)	355 651

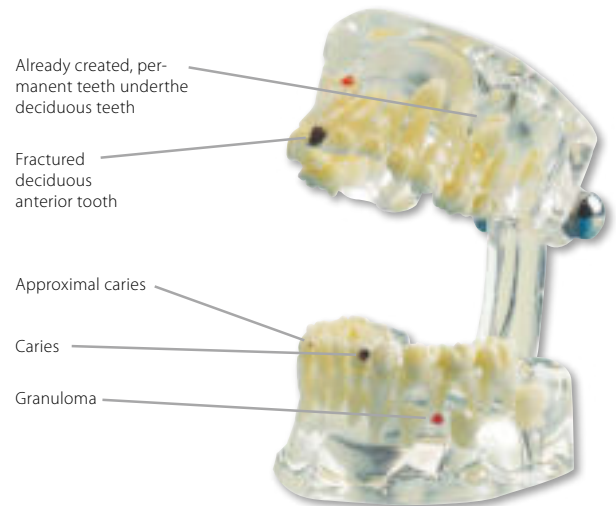

Study Model Demo Implant C+B

Transparent demonstration model of various prosthetic works

- Demonstration of various in-/onlays and implant works
- Scale 1:1
- 11 removable works for patient information (available to order)
- Made of solid and transparent polymer material

Article(s)	REF
Study Model Demo Implant C+B	355 638
Replacement restorations (11 pcs.)	355 639

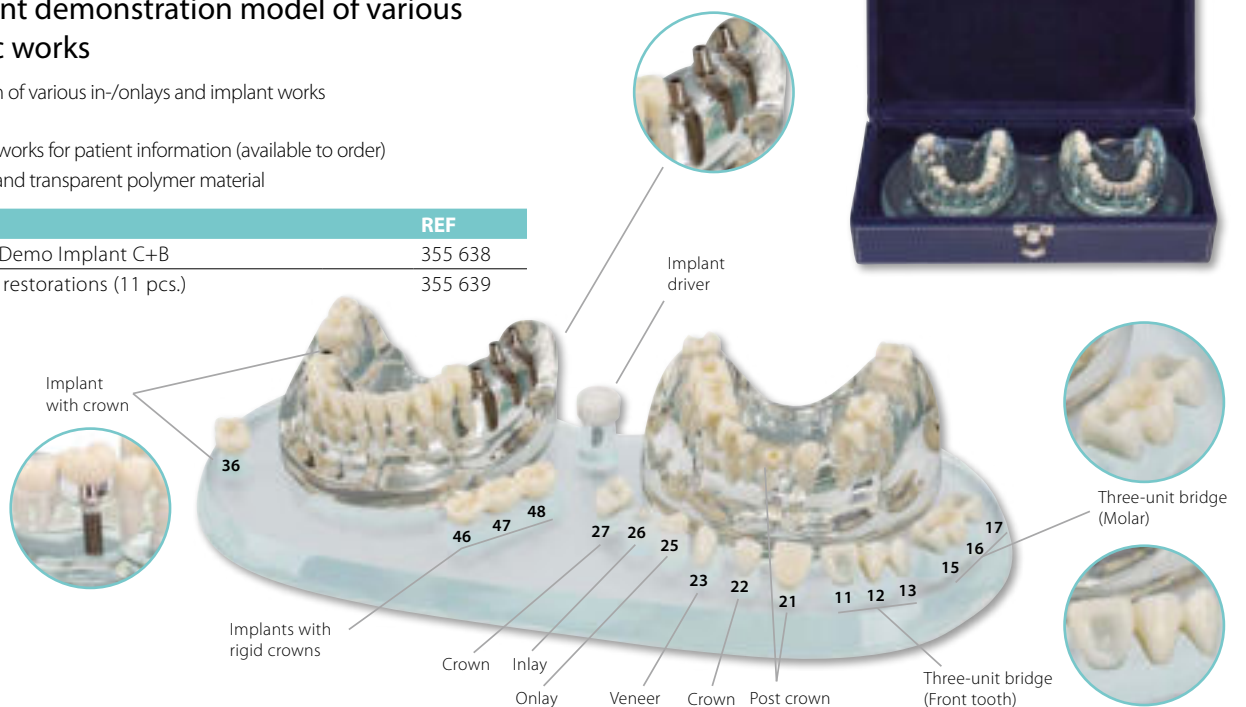



Emmenix® Flap

Soft bite X-ray cushion

- Special foamed material with high adhesion
- Flap can be fixed to the film optimally and anywhere
- Ideal for bitewing, front, premolar and molar X-ray pictures

Article(s)	Content(s)	REF
Emmenix Flap	500 pcs.	656 303

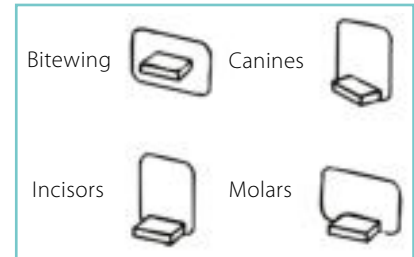

Salibag

Protective pouch for X-ray sensors

- Sensor gets inserted in the protective pouch and placed in the patient's mouth for radiography
- Protects the patient, the practice personnel and the sensor against humidity, saliva and blood
- High patient comfort by soft material
- Rounded edges, no risk of irritation
- Size: 36 x 105 mm

Article(s)	Content(s)	REF
SLB-L, for CCD Sensor S/M	320 pcs.	656 232

Bio Sensor Sleeves

Hygienic protective sleeves for x-ray sensors

- Very soft and tactile material
- Biodegradable

Size
 small: 42 x 200 mm
 medium: 45 x 200 mm



Article(s)	Content(s)	REF
Bio Sensor (small)	500 pcs.	640 070
Bio Sensor (medium)	500 pcs.	640 071

Protectoray

X-ray shield

- Safe by 0.5 mm lead lining
- In compliance with DIN EN 61331-3
- Approved by the German Institute of Radiation Safety, Munich
- Convenient for the patient – no heavy lead apron
- Easy exchange of handle



Protectoray wall mount

Article(s)	REF
Shield and handle	656 127
Wall holder transparent, separately	656 128
Handle exchangeable, separately	656 701
Wall holder separately blue, silver or white	on request



Emmenix® Film Holder

Hygienic X-ray film holder

- Film is easily positioned in the patient's mouth without the use of a finger (no irritation of mucosa, no gag reflex)
- Precise, as no bending of the film, no distortion of the picture
- For pictures of anterior teeth and molars, especially wisdom teeth
- Autoclavable, high-quality, unbreakable plastic
- In two colors: white and blue

Article(s)	REF
Pack, 3 holders assorted (2 x white, 1 x blue)	656 300



Anti-Stress Tooth

Effective relaxation aid

- By squeezing the tooth, the patient gets pleasantly distracted
- Ideal for stress relaxation or as a gift
- Material: polyurethane
- Dimensions: 64 x 54 x 38.5 mm, weight: 42 g

Article(s)	REF
Anti-Stress Tooth	707 002



Disclosing makes the PTC up to 3 times more effective!

Mira-2-Ton®

Plaque disclosing test

- Older plaque turns blue, newer plaque turns pink
- Proven in dental offices for over 30 years
- Motivating quality control for both assistant and patient
- Erythrosine and gluten-free
- Discoloration can be removed again by tooth brushing

WHY COLOR BIOFILM?

- Biofilm is barely visible to dentist and patient
- Motivates patients to improve oral hygiene
- Supports dental professionals and makes problem areas visible



Source: Dr. Andrea Thumeyer

Before



Source: Dr. Andrea Thumeyer

After

Mira-2-Ton® Solution

Plaque disclosing solution

Article(s)	Content(s)	REF
Mira-2-Ton Solution	60 ml	605 655

Mira-2-Ton® Pellets

Saturated plaque disclosing pellets

Article(s)	Content(s)	REF
Mira-2-Ton Pellets	250 pcs.	605 662

Mira-2-Ton® Tablets

Plaque disclosing tablets

Article(s)	Content(s)	REF
Mira-2-Ton Tablets	6 pcs.	630 027
Mira-2-Ton Tablets	5 x 10 pcs.	605 765
Mira-2-Ton Tablets	250 pcs. (loose)	605 768
Mouth Mirror (ø 23 mm) separately	blue transp.	630 065
Mira-2-Ton Tabl., Display	16 pkg.	635 027

Find more Mira-2-Ton products on page 64

PROPHYLAXIS

Happy Morning®

Single-use toothbrushes

- Hygienic toothbrushes with or without toothpaste
- Pre-treatment preparation
- Fresh breath

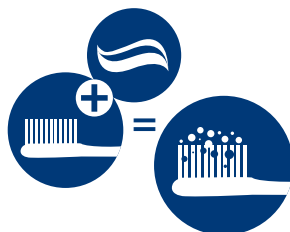

Article(s)	Content(s)	REF
Impregnated with toothpaste	100 pcs.	605 401
Without toothpaste	100 pcs.	605 403
With xylitol (see page 67)	50 pcs.	605 496

2,5 cm



paroguard®

Patient-friendly mouth rinse

- Use before prophylaxis appointments
- Fluoride (250 ppm) for remineralization
- Especially for use with limited oral hygiene abilities
- Astringent and refreshing taste with witch hazel
- Anticariogenic due to xylitol
- Alcohol-free, contains xylitol

Article(s)	Content(s)	REF
paroguard (pump not included)	5000 ml	630 127
Pump dispenser, separately		630 138
paroguard (no illustration)	200 ml	630 087

See page 68 for more products



Dosing pump

For easy-to-measure doses of the mouth rinsing solution

Mira Clean

Dissolving mouthwash tablets

- Refreshing, cleaning, cooling
- The little extra service for the patient
- Also ideal for prophylactic treatments
- Pastilles dissolve quickly
- Two pleasant flavors: mint and thymol

Article(s)	Content(s)	REF
Mint (green)	1000 pastilles	605 504
Thymol (pink)	1000 pastilles	605 505





Mira-Clin P®

Intensive cleaning polishing paste

- For professional tooth cleaning in the dental practice
- Excellent cleaning effect
- Gently removes plaque and discoloration
- Maintains the hard substance of the teeth
- Fluoride-free, pleasant fruity flavor

Article(s)	Content(s)	REF
Mira-Clin P	250 g	605 656
Mira-Clin P and finger ring II	200 x 2 g	605 658
Finger ring II, separately		605 444
Dapp-a-Way Ring + 1,000 cups, no illustration		605 445

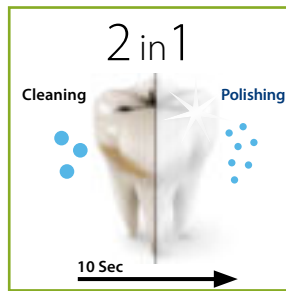

Mira-Clin® hap

Polishing paste with hydroxyapatite

- For professional tooth cleaning and polishing
- Gently cares for sensitive tooth necks
- Gently removes plaque and discoloration
- Builds a protective layer on teeth and tooth necks
- Maintains the hard substance of the teeth

Article(s)	Content(s)	REF
Mira-Clin hap	75 ml	605 654
Mira-Clin hap, cups	100 pcs. à 2 g	605 661



Mirafloss® Big

Wall-mountable dispensing box

- Ideal for professional use in the dental office
- Sharp metal edge for one-handed operation
- Refillable

Article(s)	Content(s)	REF
Mirafloss Big (white, waxed / black, waxed, mint)	2 x 200 m	605 735
Refill: black, waxed, mint	200 m	605 737
Refill: white, waxed	200 m	605 736
Refill: white, unwaxed	200 m	605 738

Prophy-Cup®

Rubber cups for prophylaxis

- Single-use only
- BPA and latex free

Article(s)	Content(s)	REF
Screwable, regular, blue	1) 50 pcs.	605 832
Screwable, soft, green	1) 50 pcs.	605 833
Snap on, regular, blue	2) 50 pcs.	605 830
Snap on, soft, green	2) 50 pcs.	605 831
Contra angle, regular, blue	3) 50 pcs.	605 834
Contra angle, soft, green	3) 50 pcs.	605 835

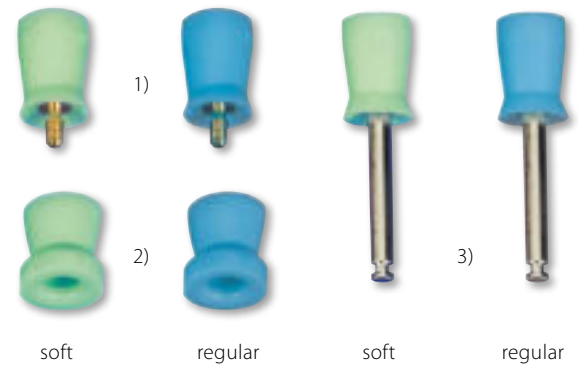

Prophy-Angles®

Single-use rubber cup attachments

- Optimal cleaning and polishing
- For handpieces only

Article(s)	Content(s)	REF
Regular, violet	100 pcs.	605 836
Soft, green	100 pcs.	605 837



Prophy-Brush®

Single-use prophylactic brushes

- BPA-free
- Effective biofilm removal
- For contra-angle handpieces

Article(s)	Content(s)	REF
Prophy-Brush cylinder, fine, flat, ø 3.7 mm	50 pcs.	605 870
Prophy-Brush cylinder, regular, flat, Inside ø 3.0 mm, Outside ø 7.1 mm	50 pcs.	605 871



Rotoprox®

Micro spiral brush/plastic brush with stainless steel shaft

- For cleaning and polishing e.g. fissures or inaccessible areas
- For contra-angle handpieces and extraoral use

Rotoprox Mini with stainless steel shaft

Article(s)	Content(s)	REF
Flat (20 mm long)	50 pcs.	605 792

Rotoprox with stainless steel shaft

Rotoprox, for CA ø 2.0 mm x-fine/straight 27 mm long	10 pcs.	605 719
Rotoprox, for CA ø 2.2 – 2.5 mm fine/conical 27 mm long	10 pcs.	605 721

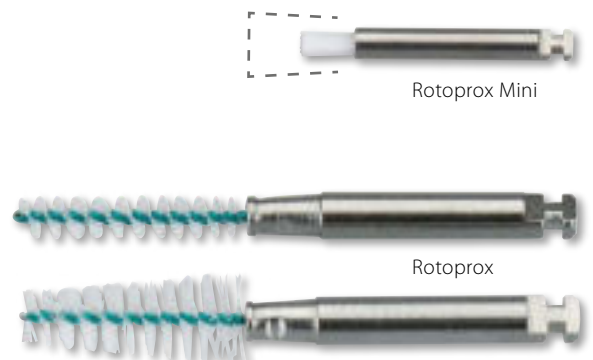



Miradont®-Gel

Micronutrient gel for intensive oral care

- Accompanying therapy in aphthae and oral lesions
- Regenerating and revitalizing
- For irritated and stressed oral mucosa
- No added alcohol, saccharin, menthol, and preservatives
- Menthol, Magnesium, Sage extract, Clove oil, Zinc, Vitamin E, Panthenol, White tea extract

Article(s)	Content(s)	REF
Miradont-Gel	15 ml	155 000



Mirafluor®-Tray

Application tray for fluoride gel

- Made of light, flexible material
- Double tray for simultaneous treatment of maxilla and mandible

Article(s)	Content(s)	REF
Mirafluor-Tray, small	50 pcs.	605 620
Mirafluor-Tray, medium	50 pcs.	605 621
Mirafluor-Tray, large	50 pcs.	605 622

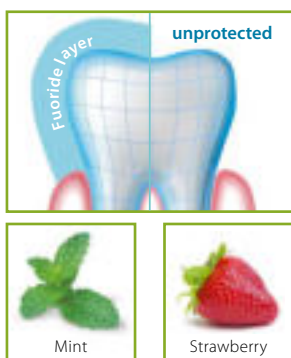

mirafluor®-gel

Fluoride gel

- For caries prophylaxis with sodium fluoride
- For remineralisation of the tooth enamel
- With 1.23 % fluoride (NaF)

Article(s)	Content(s)	REF
mirafluor-gel, mint	250 ml	605 800
mirafluor-gel, strawberry	250 ml	605 801



Mirafluorid®

Fluoride varnish on emulsion basis with 0.15 % fluoride

- For precise application, can also be applied in a humid environment

Article(s)	Content(s)	REF
Mirafluorid	5 ml	605 810

We recommend our Mirabrush brushes for application (see page 16).



Further information can be found from page 62

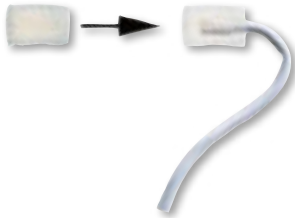

Comfi-Tips

Aspiration pads for saliva ejectors

- Avoid suction to the oral mucosa
- Prevent pain from cold drafts on sensitive tooth necks
- Reduce the typical suction noise
- Increase patient comfort
- Made of foam

Article(s)	Content(s)	REF
Comfi-Tips	100 pcs.	605 286



Chirurgo-Suc I

Sterile single-use surgical aspiration cannulas

- Extremely long (20 cm) for unobstructed work area
- Fits all hoses with adapter (REF 254 130 and 254 132 – s. S. 39)
- Individually sterile sealed, clear plastic

Article(s)	Content(s)	REF
Chirurgo-Suc I (without adapter)	10 pcs.	254 000

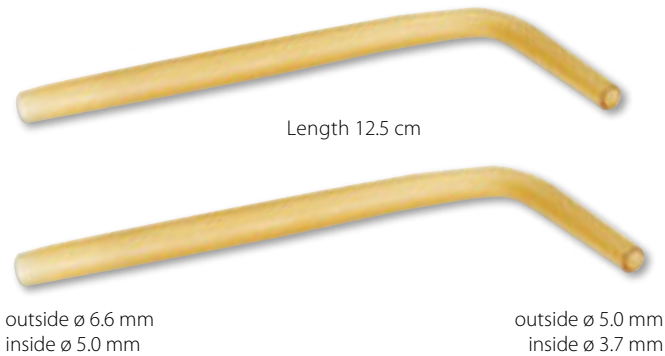

Steri-Suc-Tube

Aspiration cannula

- Made of high-quality, transparent, honey-colored plastic
- Safe in contact with activated electrodes (see page 55) or rotating instruments
- Fits to saliva ejector (6 mm) without adapter
- Ultra-light, approx. 3 g weight
- Includes one Chiru-Cleaner brush (No. 19, REF 605 215)
- Autoclavable

Article(s)	Content(s)	REF
Steri-Suc-Tube	10 pcs.	254 060

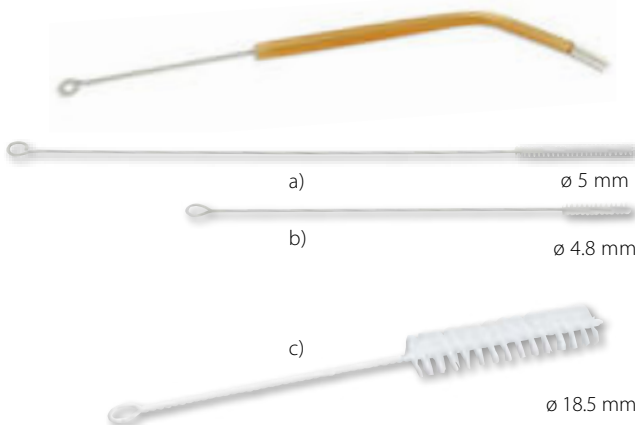

Chiru-Cleaner® / Mirasuc® Brush

Cleaning brushes for surgical canulas

Article(s)	Content(s)	REF
a) Chiru-Cleaner 19, 19 cm long	12 pcs.	605 215
b) Chiru-Cleaner 16, 16 cm long	6 pcs.	605 217

Cleaning brush for aspiration cannulas

- Bendable, ideal for cleaning the inside of cannulas
- Fits all 11 mm and 16 mm ø aspiration cannulas, 18.5 cm length

Article(s)	Content(s)	REF
c) Mirasuc Brush, 18.5 cm long	6 pcs.	605 216

ASPIRATION | RUBBER DAM

Swe-Flex

Single-use saliva ejector with tongue holder

- For draining the oral cavity
- Holds back the tongue
- Flexibly adapts to the patient
- Optimal suction effect
- To be inserted between the tongue and the dental arch



Article(s)	Content(s)	REF
Swe-Flex	100 pcs.	254 032

Pelotte-Aspirator / Pelotte Plus

Single-use plastic aspiration cannulas

- Round head cannula
- ø 11 mm, length 10 cm

Article(s)	Content(s)	REF
Pelotte-Aspirator, white, incl. 1 adapter (from ø 11 to 16 mm)	50 pcs.	254 022
Pelotte-Aspirator, orange, incl. 1 adapter (from ø 11 to 16 mm)	50 pcs.	254 023
Pelotte Plus, green, incl. 1 adapter (from ø 11 to 16 mm), autoclavable, no illustration	10 pcs.	254 024



Mirasucto®

Long single-use plastic aspiration cannulas

- Square head cannulas
- ø 11 mm, length 14 cm

Article(s)	Content(s)	REF
Mirasucto, white	50 pcs.	254 020



Pelotte Bio

Single-use suction cannula with valve

- Double tips: S-shape + S-shape
- Ventilated to prevent blockage
- No phthalates, no latex
- Made from environmentally friendly Green PE
- Length: 145 mm, ø 11 mm
- Optional adapter 11 to 16 mm

Article(s)	Content(s)	REF
Pelotte Bio	100 pcs.	640 090



Mirasuc® Adapter

Extensions and connecting pieces for aspiration cannulas

- Made of plastic, for all conventional suction units
- Extension from 6 mm to 16 mm (d) possible by combination of adapters (a) and (c)

Article(s)	REF
a) White, autoclavable, from 11 mm to 16 mm	254 130
b) Gray, autoclavable, finger-grip handle extends the cannula from 11 mm to 16 mm	254 133
c) White, from 6 mm (salvia ejector) to 11 mm	254 132
d) Combination of adapter a) and c) from 6 mm to 16 mm	

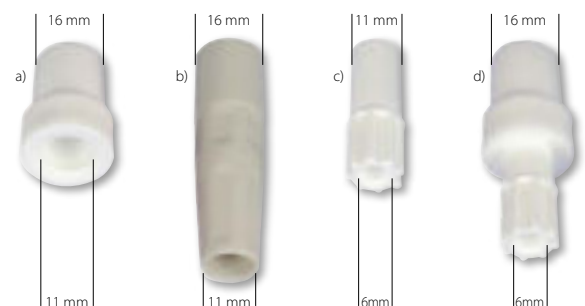

Similar to illustration



Fit-Kofferdam® Starter Kit I

Basic equipment I for rubber dam technique

- 1 Board with 12 clamps complete
- 1 Pair of Fit clamp forceps
- 1 Fit punch
- 1 Fit steel frame large
- 1 Fit rubber dam booklet

Fit-Kofferdam® Starter Kit II

Basic equipment II for rubber dam technique

- 1 Board with 12 clamps complete
- 1 Pair of Fit clamp forceps
- 1 Fit punch
- 1 Fit latex medium (36 sheets)
- 1 Fit folding frame (plastic)
- 1 Perforated template
- 1 Fit rubber dam booklet

Article(s)	REF
Fit-Kofferdam Starter Kit I	355 320
Fit-Kofferdam Starter Kit II	355 338

Fit-Kofferdam® Clamp Board

Clamp board available with and without clamps

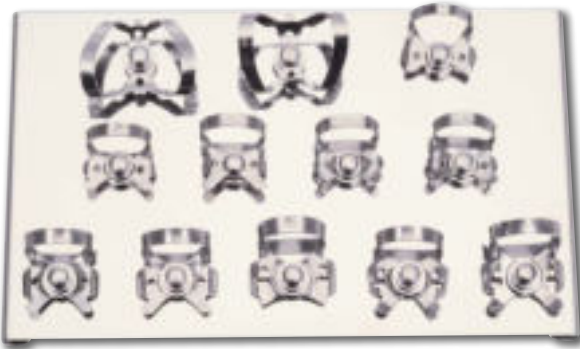

Stainless steel board, with 8 clamps

2 x No. 9, 1 x each: Nos. 2A, W2A, 5, 56, 203, 204

Stainless steel board, with 12 clamps

1 x each: Nos. 5, 7, 9, 56, 201, 202, 206, 207, 210, 0, 2, 2A

Stainless steel board, with 18 clamps

1 x each: Nos. P1, P2, 7, 9, 18, 22, 27, 29, 201, 202, 203, 204, 205, 208, 209, 138, 139, 210

Article(s)	REF
Clamp board with 8 clamps	355 330
Clamp board with 12 clamps	355 331
Clamp board with 18 clamps	355 332
Clamp board without clamps (for 8 clamps)	355 327
Clamp board without clamps (for 12 clamps)	355 328
Clamp board without clamps (for 18 clamps)	355 329

Fit-Kofferdam® Perforating Template

For marking holes in rubber dams prior to perforation

- Solid plastic

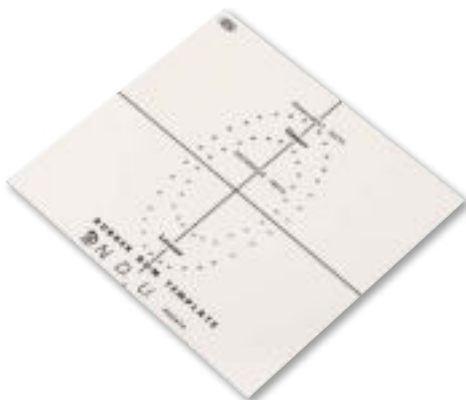

Article(s)	REF
Fit-Kofferdam Perforating Template, 15 x 15 cm	355 318

ASPIRATION | RUBBER DAM

Fit-Kofferdam® Clamp Forceps

For easy gripping of the clamps

- Freely lockable
- No tilting of the clamp possible
- 17 cm long

Article(s)	REF
Fit-Kofferdam Clamp Forceps	355 333



Fit-Kofferdam® Punch

For perfectly punched, tear-resistant perforations

- Movable punch pin always uses the entire cutting edge
- Made of stainless steel
- 16 cm long

Article(s)	REF
Fit-Kofferdam Punch	355 321



Fit-Kofferdam®-Latex

Made of natural latex rubber

- Medium: extra smooth due to approximal contact
- Heavy: for stronger gingival retention
- High tensile strength due to consistent quality
- Shelf life of at least one year when stored in a cool place
- Green (15 x 15 cm), powdered on one side

Article(s)	Thickness	Content(s)	REF
Latex, medium	0.18–0.23 mm	36 sheet	355 335
Latex, heavy	0.23–0.29 mm	36 sheet	355 336



Fit-Kofferdam® Steel Frame

Solid stainless steel frame

- Tightens rubber dam without perforation
- Autoclavable
- Available in two sizes

Article(s)	REF
Steel Frame I, large	355 324
Steel Frame II, small	355 323

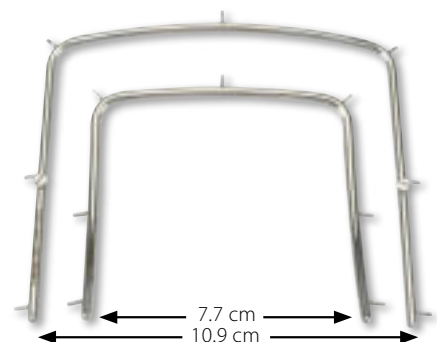

Fit-Kofferdam® Folding Frame

Foldable plastic frame

- Folds in half for easy access
- Avoids reflections on control radiographs, ideal for endodontics
- Autoclavable
- Weight: 16 g

Article(s)	REF
Fit-Kofferdam Folding Frame	355 319



Fit-Kofferdam® Clamps overview

Permanent teeth

6 9 9T 210 winged				212 90N wingless		9 9T 2A 2AT winged			
For labial cavities.	Most popular anterior clamp.	Most popular anterior clamps.	For centrals.	Cervical clamp for labial cavities.	Strong anterior clamp.	Most popular anterior clamp.	Most popular anterior clamps	Similar to No. 2 but with larger beaks.	Similar to No. 2T but with larger beaks.

4 205 5 8A 201 14 14T winged							51 26 W8A U67 18 wingless				
Similar to No. 3, but with festooned beaks.	For upper molars with stiff spring.	For upper molars.	For upper roots with strong festooned beaks.	With festooned beaks.	For half erupted molars.	For half erupted molars.	For beaked molars with both side beaks.	For upper molars especially for erupted tooth.	Similar to No. 8A but wingless.	For upper second molars, compact.	For upper + lower molars, round type beak.

56T 14T 3 winged			51 31 30 25 W8A 18 wingless					
For lower molars with festooned beaks.	For half erupted molars.	For small molars, flat beaks.	For beaked molars with both side beaks.	For beaked molars.	For beaked molars.	For deep buccal cavities of molars, wider fringe.	Similar to No. 8A but wingless.	For upper + lower molars, round type beak.

1 1T 1AT winged			22 27 W2A wingless			203 204 202 201 winged			
For roots, deep festooned beaks.	For roots, deep festooned beaks.	For cervical cavities of bicuspid.	Similar to No. 207 but wingless.	Wingless, festooned beaks.	Similar to No. 2A but wingless.	For small lower molars, right + left.	For small lower molars, right + left.	For large molar clamp.	With festooned beaks.

207 208 2A 2AT winged				9 9T 2 2T winged				212 22 wingless	
For upper + lower bicuspid, with flat beaks.	For big bicuspid with similar pattern of No. 207.	Similar to No. 2 but with larger beaks.	Similar to No. 2T, but with larger beaks.	Most popular anterior clamp.	Most popular anterior clamps	For lower bicuspid with flat beaks.	For lower bicuspid with flat beaks.	Cervical clamp for labial cavities.	Similar to No. 207 but wingless.

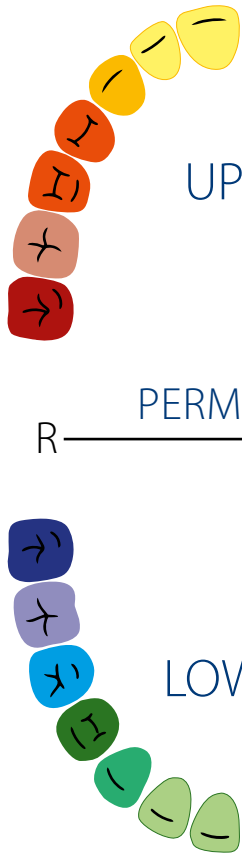

ASPIRATION | RUBBER DAM

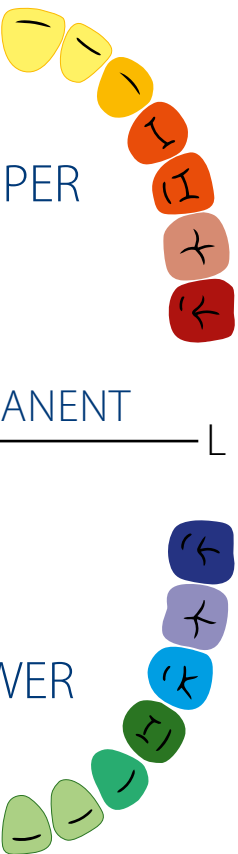

212 29
wingless



Cervical clamp for labial cavities.
For upper + lower bicuspid, broad beaks for wider.

208 207 206 1T
winged



For big bicuspid with similar pattern of No. 207.
For upper + lower bicuspid with flat beaks.
For upper + lower bicuspid with festooned beaks.
For roots, deep festooned beaks.

22 27 29
wingless



Similar to No. 207 but wingless.
Wingless, festooned beaks.
For upper + lower bicuspid, broad beaks for wider.

28
wingless



For upper - lower molars. Very wide fringe for broad sight.

205 5 8A 201 14A 4 8
winged



For upper molars with stiff spring.
For upper molars.
For upper roots with strong festooned beaks.
With festooned beaks.
Similar to No. 14, but with larger beaks.
Similar to No. 3 but with festooned beaks.
For upper molars with round beaks.

7A 14A 14T 56T
winged

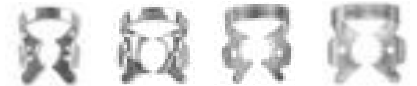

For very big lower molars.
Similar to No. 14, but with larger beaks.
For half erupted molars.
For lower molars with festooned beaks.

202 14 56 7
winged



For large molar clamp.
For half erupted molars.
Similar to No. 5 but with festooned beaks.
For lower molars with flat beaks.

W3 31 30 28 25 15
wingless



Similar to No. 3 but wingless.
For beaked molars.
For beaked molars.
For upper - lower molars. Very wide fringe for broad sight.
For deep buccal cavities of molars, wider fringe.
For big lower molars, wide beak strong spring.

29 22 27 W2A
wingless



For upper + lower bicuspid, broad beaks for wider.
Similar to No. 207 but wingless.
Wingless, festooned beaks.
Similar to No. 2A but wingless.

2T 2A 2AT 1 1T 1AT
winged



For lower bicuspid with flat beaks.
Similar to No. 2 but with larger beaks.
Similar to No. 2T, but with larger beaks.
For roots, deep festooned beaks.
For roots, deep festooned beaks.
For cervical cavities of bicuspid.

9 9T
winged



Most popular anterior clamp.
Most popular anterior clamp.

212
wingless



Cervical clamp for labial cavities.

207 209 0 00
winged



For upper + lower bicuspid, with flat beaks.
For lower bicuspid, with flat beaks.
For small bicuspid and pedo central.
Smaller than No. 0.

Fit-Kofferdam® Clamps

overview

Milk teeth jaw

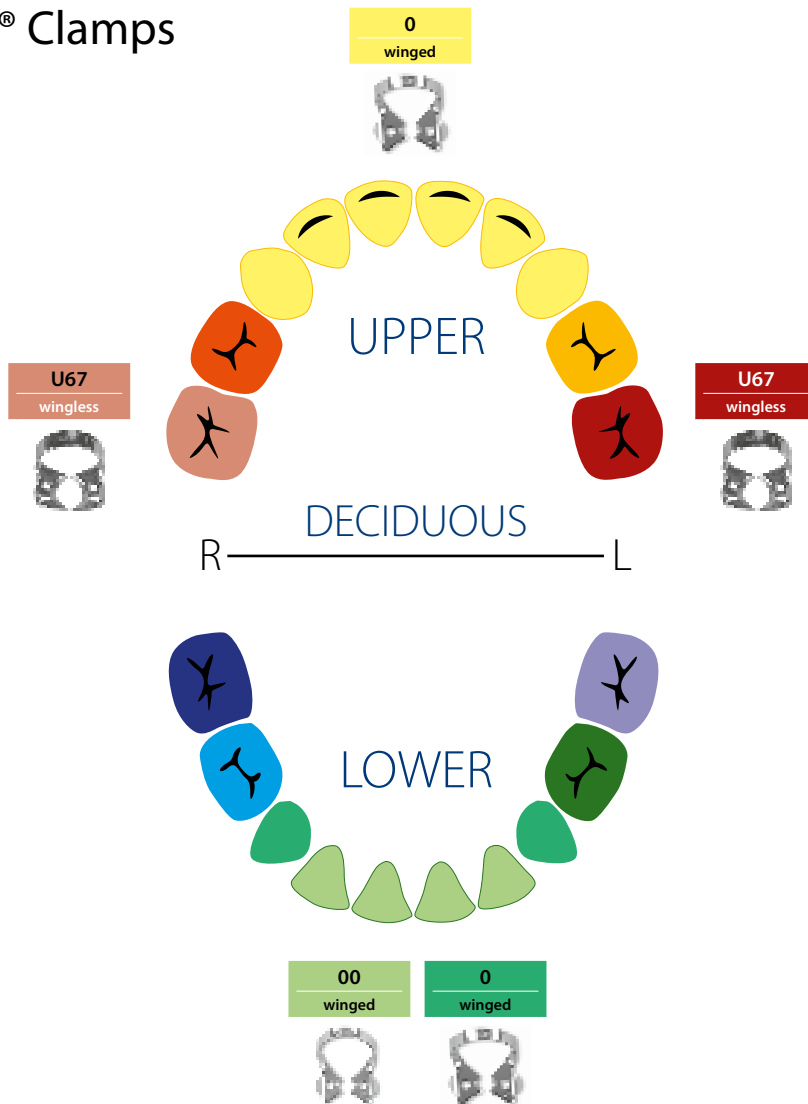

Special Clamps

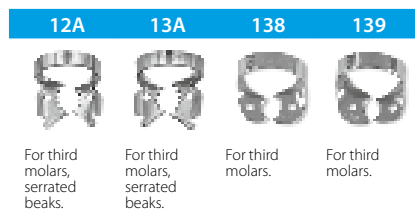

Clamp Boards

Deciduous Clamp Board

- Stainless steel
- Size: 90 x 90 mm
- No. 55-upper right E
- No. 54-upper right D
- No. 64-upper left D
- No. 65-upper left E
- No. 84-lower right D
- No. 85-lower right E
- No. 74-lower left D
- No. 75-lower left E

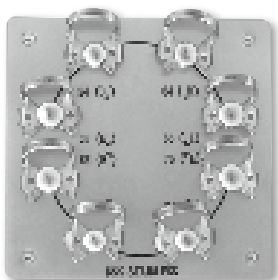

Clamp Board No. 12

- Stainless steel
- Size: 150 x 190 mm
- With 12 clamps: No. 201, 211, 0, 2, 2A, 206, 207, 5, 56, 7, 201 + 202

No.	Description	REF
9	Ivory-Style	355 355
9T	Anterior clamp with wings	355 754
210	Ivory-Style	355 384
212	Ivory-Style	355 386
90N	Strong anterior clamp wingless	355 371
6	For labial cavities, with wings	355 390
0	Premolar clamp with wings	355 340
9	Ivory-Style	355 355
9T	Anterior clamp with wings	355 754
2A	Premolar clamp with wings	355 344
2AT	Premolar clamp with wings	355 751
212	Ivory-Style	355 386
29	Premolar clamp wingless	355 366
208	Premolar clamp with wings	355 382
207	Premolar clamp with wings	355 381
206	Premolar clamp with wings	355 380
1T	For roots, with wings	355 752
22	Premolar clamp wingless	355 360
27	Premolar clamp wingless	355 364
29	Premolar clamp wingless	355 366
205	Molar clamp with wings	355 379
5	Molar clamp with wings	355 349
8A	Molar clamp with wings (deep gripping)	355 353
201	Molar clamp with wings	355 375
14A	Molar clamp with wings (deep gripping)	355 357
4	Molar clamp with wings (deep gripping)	355 348
8	Molar clamp with wings (deep gripping)	355 352
28	Molar clamp wingless	355 365
U67	Wingless	355 403
4	Molar clamp with wings (deep gripping)	355 348
205	Molar clamp with wings	355 379
5	Molar clamp with wings	355 349
8A	Molar clamp with wings (deep gripping)	355 353
201	Molar clamp with wings	355 375
14	Molar clamp with wings (deep gripping)	355 356
14T	For half erupted molars, with wings	355758
51	Molar clamp wingless	355 369
26	Molar clamp wingless	355 363
W8A	Molar clamp wingless	355 354
U67	For upper second molars, wingless	355 403
18	Molar clamp wingless	355 359
202	Molar clamp with wings	355 376
14	Molar clamp with wings (deep gripping)	355 356
56	Molar clamp with wings	355 370
7	Molar clamp with wings	355 350
W3	For small molars, wingless	355 347
31	Molar clamp wingless	355 368
30	Molar clamp wingless	355 367
28	Molar clamp wingless	355 365
25	Molar clamp wingless	355 362
15	Molar clamp wingless	355 358
7A	Molar clamp with wings	355 351
14A	Molar clamp with wings (deep gripping)	355 357

14T	For half erupted molars, with wings	355 758
56T	For lower molars, with wings	355 759
56T	For lower molars, with wings	355 759
14T	For half erupted molars, with wings	355758
3	Molar clamp with wings (deep gripping)	355 346
51	Molar clamp wingless	355 369
31	Molar clamp wingless	355 368
30	Molar clamp wingless	355 367
25	Molar clamp wingless	355 362
W8A	Molar clamp wingless	355 354
18	Molar clamp wingless	355 359
203	Molar clamp with wings	355 377
204	Molar clamp with wings	355 378
202	Molar clamp with wings	355 376
201	Molar clamp with wings	355 375
1	For roots, with wings	355342
1T	For roots, with wings	355 752
1AT	For cervical cavities of premolars, with wings	355 753
22	Premolar clamp wingless	355 360
27	Premolar clamp wingless	355 364
W2A	Premolar clamp with wings	355 345
207	Premolar clamp with wings	355 381
208	Premolar clamp with wings	355 382
2A	Premolar clamp with wings	355 344
2AT	For lower premolars, with wings	355 751
9	Ivory-Style	355 355
9T	Anterior clamp with wings	355 754
2	Premolar clamp with wings	355 343
2T	For lower premolars, with wings	355 750
212	Ivory-Style	355 386
22	Premolar clamp wingless	355 360
0	Premolar clamp with wings	355 340
2T	For lower premolars, with wings	355 750
2A	Premolar clamp with wings	355 344
2AT	For lower premolars, with wings	355 751
1	For roots, with wings	355342
1T	For roots, with wings	355 752
1AT	For cervical cavities of premolars, with wings	355 753
29	Premolar clamp wingless	355 366
22	Premolar clamp wingless	355 360
27	Premolar clamp wingless	355 364
W2A	Premolar clamp wingless	355 345
207	Premolar clamp with wings	355 381
209	Premolar clamp with wings	355 383
0	Premolar clamp with wings	355 340
00	Premolar clamp with wings	355 341
9	Ivory-Style	355 355
9T	Anterior clamp with wings	355 754
212	Ivory-Style	355 386
12A	For wisdom teeth	355 404
13A	For wisdom teeth	355 405
138	For wisdom teeth	355 777
139	For wisdom teeth	355 778



X-ray control



Endo N2®

Root canal cement based on zinc oxide-eugenol

- Economical and fast alternative for over 50 years
- Can be used alone or as a sealer connection with Gutta Percha points
- Easily rotated into the canal
- Adheres well to canal walls
- Definite, non-absorbable filling with a chalk-like hardness after curing
- Antimicrobial effect gradually diminishes as it sets
- Powder and liquid for mixing

Article(s)	Content(s)	REF
Set	10 g powder, 6 g liquid	152 027
Powder separately	10 g	152 028
Liquid separately	6 g	152 029

"Of more than 8,800 vital extirpations registered in the EDP system in the period 1985-1999, only 22 cases were treated in more than one session (5 self-treatments, 17 as an assistant). I have not counted thousands of vital amputations and milk tooth endos." Dr. Robert Teeuwen

Gold-plated

Titanium

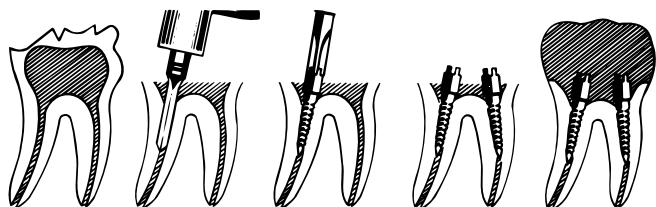

Mirapost®

Economic build-up posts

- Self-cutting thread
- Two versions: titanium or 24 K gold-plated
- For direct cementation or screw fixation
- Four lengths: short (8 mm), medium (9.5 mm), long (12 mm), x-long (14 mm)
- Available in six diameters: No. 1 (ø 1.05 mm), No. 2 (ø 1.20 mm), No. 3 (ø 1.35 mm), No. 4 (ø 1.50 mm), No. 5 (ø 1.65 mm), No. 6 (ø 1.80 mm)
- Sets of three, six or twelve posts per size

Gold-plated set with hollow and cross-type driver, titanium set with hollow driver

Article(s)	Content(s)	REF
Set 240, gold-plated	20 x 12 pcs.	355 975
Set 120, titanium	20 x 6 pcs.	355 998
Set 60, gold-plated	20 x 3 pcs.	355 974
Set 60, titanium	20 x 3 pcs.	355 973

Reamer

Set 1-6	6 pcs.	355 997
No. 1	ø 1.05 3 pcs.	356 020
No. 2	ø 1.20 3 pcs.	356 021
No. 3	ø 1.35 3 pcs.	356 022
No. 4	ø 1.50 3 pcs.	356 023
No. 5	ø 1.65 3 pcs.	356 024
No. 6	ø 1.80 3 pcs.	356 025
Hollow driver, separately		356 027
Cross-type driver, separately		356 028

More details on request

Miraclean-Implant Black

Plastic instruments for implants

- Black colored instruments for good contrast
- Double-ended, in four special shapes
- Autoclavable plastic material



Article(s)	REF
Set with 4 instruments	355 220
Instrument separately: No. 1, posterior tooth	355 221
Instrument separately: No. 2, Luniatschek + scaler	355 222
Instrument separately: No. 3, anterior tooth	355 223
Instrument separately: No. 4, abutment	355 224



Artiholder

Blue Paper Holder

- Straight version (Miller forceps)
- Ideal for the posterior region
- Made of high-quality stainless steel

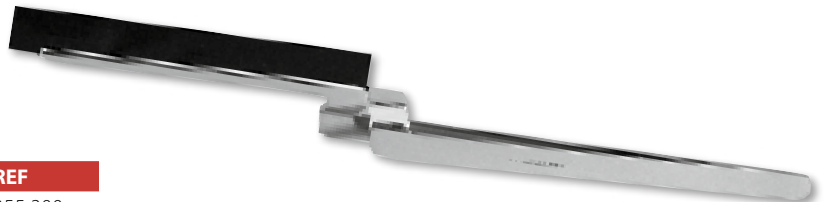

Article(s)	REF
Artiholder, straight	355 300

Matrix-Spanner

Matrix retainer "Tofflemire" style

- High-quality stainless steel
- Autoclavable



Article(s)	REF	€
Universal No. 1	355 043	15,99
Angled No. 2	355 047	15,99
Junior (short) No. 3	355 048	15,99





6 sewn on layers

Super-Splint

Single-layer fiberglass tape for splinting and reinforcement

- Extremely flexible and easy to work with
- Multiple layers of tape can be stacked with composite
- 4 mm wide, silanized for up to 50 applications

Article(s)

REF

Super-Splint, 3 m tape

355 849



Amalgam Well

Amalgam depot made of stainless steel

- Flat base for easy pick up
- Allows amalgam to be collected without skin contact
- Stable and non-slip, autoclavable
- Height: approx. 3 cm, ø opening top: approx. 2 cm, weight: 123 g



Article(s)

REF

Amalgam Well

355 000



Delject

Plastic amalgam carrier

- Autoclavable

Article(s)

REF

Delject, 90° angle

355 036



Crown Click® De Luxe

Mechanical crown and bridge remover

- Highly effective with pulse wave
- Simply place the tip of the instrument under the crown margin and release the "click"
- Three tip designs with additional loop (optional)
- Quick, efficient and easy crown and bridge removal
- High-quality, satin-finished stainless steel
- Autoclavable



Article(s)	REF
Set: Instrument with tips (No. 1 – 3)	452 205
Tip No. 1 (long)	452 206
Tip No. 2 (short)	452 207
Tip No. 3 (short + angle)	452 208
Loop tip No. 4 (with adapter)	452 209
Loop tip replacement wire, 2 pcs.	452 210

Compo Blitz Polierer

Diamond impregnated natural felt wheel

- For high-gloss polishing of composites and ceramics
- Polishing time 15 sec., friction temperature below 30 °C
- Mounted for contra-angle handpiece
- Wheels with ø 9 mm in 2 thicknesses:
 - 1.5 mm / thin and
 - 3 mm / thick



Article(s)	Content(s)	REF
Set assorted, 6 x thin, 6 x thick	12 pcs.	503 086
Thin 1.5 mm	12 pcs.	503 087
Thick 3 mm	12 pcs.	503 088

Gripit®

Bite-cushion with high adhesion force

- For removal of temporary work
- Heat bite-cushion, put in place and remove temporary work by instructing the patient to open their mouth jerkily
- Safe and very convenient for the patient
- Two pieces hygienically packed

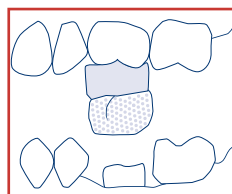
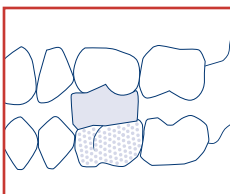

Article(s)	Content(s)	REF
Gripit	50 (25 x 2) pcs.	605 283



Proto-Cam®

Face shield

- Premium viewing quality: no reflections, no distortion
- Very robust, durable polycarbonate
- Safe working with the prophylaxis blasting device
- Ultra-light design (only 28 g)
- Shield dimensions: 23 cm x 16.2 cm



Article(s)	Content(s)	REF
Proto-Cam	white frame with 5 protective shields and 1 headband	355 535
Proto-Cam replacement shields	5 pcs.	355 536



Proto-Cam® Smart

Face Shield

- Full face coverage and all round protection
- Clear, unobstructed field of vision
- Lightweight design
- Slim design
- Shield dimensions: 23.5 cm x 16.5 cm



Article(s)	Content(s)	REF
Proto-Cam Smart, white	1 frame with 12 replacement shields	355 486
Proto-Cam Smart replacement shields	12 pcs.	355 484



CC-Shield

Face shield

- Highly impact-resistant and can be hinged upwards
- Fits any head size – adjustable Velcro fastening
- No light or color reflex
- For working in the laboratory, etc.
- Shield dimensions: 32.7 x 21 cm



Article(s)	REF
CC-Shield	355 508

H&W Super Fit UV (OTG)



Over-the-glasses eyewear offering broader vision

- Suitable for works with polymerization lamps (390 – 525 nm)
- Softpad technology assures ideal, ergonomic fit
- Unobstructed view to the sides
- Temple length adjustable

Frame	Lens	REF
Black	orange	355 626



38 g

H&W Classic

Stylish and comfortable
protective eyewear



- Soft sides, adjustable with lock-in-place extension
- Provides full protection with 180° unobstructed view
- Polycarbonate lens

Frame	Lens	REF
Black/green	transparent	355 622



28 g

H&W Featherlight

Ultralight protective eyewear

- Soft temples with adjustable notches
- Adjustable soft nosepiece for a superior anti-slip fit
- Comfortable full wrap-around protection
- Polycarbonate lens

Frame	Lens	REF
White/green	transparent	355 621
Hager iSpec smart, pink	transparent	355 666



22 g

Hager iSpec® Fit OTG

Lightweight overspecs

- No temple contact with prescription glasses
- Flat base curve provides good eye coverage
- Soft, extra flexible temple tips
- For ideal visual image quality



Frame	Lens	REF
Blue	transparent	355 539



37 g

Find more models here: www.hagerwerken.de

Hager iSpec® Laser safety glasses

Laser safety glasses in modern design

- (1) Laser safety glasses yellow: protection level LB4, for laser 808 – 1064 nm*, 27 g
 (2) Laser overspecs yellow: overspecs with the same features, 51 g
 (3) Laser overspecs blue: overspecs for soft diode laser 650 – 660 nm*, 51 g
 (4) Patient glasses: broadband protection with special metal inserts



(1)



(2)



Article(s)	REF
(1) Laser protective glasses, yellow	355 630
(2) Laser overspecs, yellow	355 631
(3) Laser glasses for patients	355 633

* All of our glasses are LaserHF compatible. Should you use another laser, please calculate the safety grades your laser requires and compare them with the information stated on the laser safety glasses, before using them.



Hager iSpec® Cleaning wipes for glasses

- Wet wipes for all types of spectacles
- The anti-fog and anti-scratch eyewear coatings remain protected
- Thorough and streak-free cleaning
- Also suitable for face shields
- Individually packaged (folded to 20 x 50 mm) and silicone-free

Article(s)	Content(s)	REF
Hager iSpec Cleaning wipes for glasses	100 pcs.	355 657



Miramask® FFP2

Respiratory mask

- 4-layer respiratory protection with inserted, adjustable nose clip
- Soft and elastic ear tape
- Fits well under the chin
- Particularly breathable
- Ideal for eyeglass wearer
- Water-repellent and latex free

Article(s)	Content(s)	REF
Miramask FFP2	5 pcs.	605 499
Miramask FFP2	40 pcs.	605 502
Miramask FFP2	500 pcs.	605 503

Orange Solvent®

Cleansing solution

- Removes impression pastes, zinc oxide cements, dispersion adhesives (stickers, labels) from instruments
- Ideal for cleaning stainless steel
- Leaves surfaces shiny and are protected
- Fresh orange scent
- Choose between liquid and spray

Article(s)	Content(s)	REF
Orange Solvent Liquid	250 ml	554 102
Orange Solvent Spray	200 ml	554 201



Praxipolish® Plus

Cleansing foam for dental offices

- Removes dirt, dirt rims, stains, etc. without effort
- For devices, plastic and wooden surfaces, etc.
- With ultra-hygienic features
- Tested by the neutral German "Institute for Hospital Hygiene and Infection Control" (IKI Giesen)

Article(s)	Content(s)	REF
Praxipolish Plus	400 ml	554 208



EASY CLEAN



Astro Clean

Surface disinfection

- Broad microbiological effectiveness
- Limited virucidal effect BVDV/(HCV), Vaccinia including HBV/HIV
- Suitable for use on most surfaces – dries quickly

Article(s)	Content(s)	REF
Astro Clean	250 ml	554 301



Flexbrush

Autoclavable hand brush

- Excellent for cleaning hands before and after treatment
- Extra long, durable bristles on the underside
- Short bristles on the top
- Autoclavable – meets hygiene requirements

Article(s)	REF
Flexbrush	605 254





W x H x D: 19.0 x 8.5 x 23.9 cm, Weight: approx. 2.5 kg

hf Surg Smart

For smaller surgical applications

- Operating modes permit CUT, CUT / COAG and COAG
- For scalpel-fine, pressureless, feather-light incisions with or without simultaneous coagulation for hemostasis
- Extremely fast and painless wound healing
- Lightweight (only 30 g) handpiece
- Non-slip, ergonomic handpiece grip and footswitch
- Autoclavable handpiece and electrodes

Article(s)

hf Surg Smart

REF

452 600



W x H x D: 21.8 x 12.8 x 24.0 cm, Weight: approx. 1.5 kg

hf Surg® Touch

Programmable, powerful electrocautery unit

Additional features compared to the hf Surg Smart:

- Intuitive touch display
- Individual programs
- Newest turbo processor
- 40% lighter, only 1.5 kg

Article(s)

hf Surg Touch

REF

452 650



W x H x D: 25.4 x 10.4 x 28.8, Weight: approx. 5 kg

hf Surg® BiPo

Bipolar, intra- and extraoral electrocautery unit

Additional features compared to the hf Surg Smart:

- Extended use of bipolar forceps
- Handpiece with CUT COAG switch
- Increased power range for extraoral applications

Article(s)

hf Surg BiPo

REF

452 700



hf Surg® Plus

Compact electrocautery unit

- Ideal for oral surgery
- 3 operating modes enable CUT, CUT&COAG and COAG*
- For scalpel-fine, pressureless incisions with coagulation for hemostasis
- Fast and painless wound healing

Scope of delivery: Unit with foot switch, handpiece, 6-piece electrode set plus neutral electrode

Technical data: Dimensions (W x H x D): 26.5 cm x 8.9 cm x 18 cm Weight: approx. 3.5 kg Power supply: 220 – 230 V, 50 / 60 Hz

Article(s)

hf Surg Plus

REF

452 500

hf Electrodes for hf Surg® Smart, hf Surg® Touch and hf Surg® BiPo

Article(s)	REF
hf Surg STB electrode No. 1 G	452 750
hf Surg STB electrode No. 2 A	452 751
hf Surg STB electrode No. 5 A	452 754
hf Surg STB electrode No. 11 G	452 752
hf Surg STB electrode No. 12 G	452 757
hf Surg STB electrode No. 13 G	452 753
hf Surg STB electrode No. 15 G	452 756
hf Surg STB electrode No. 31 A	452 755
hf Surg STB electrode No. 33 A	452 759
hf Surg STB electrode No. 33 G	452 758
hf Surg STB neutral electrode	452 763
Upon request: hf Surg BiPo bipolar forceps 115 mm straight (cable and adapter not included)	452 773
Upon request: hf Surg BiPo bipolar forceps 115 mm curved (cable and adapter not included)	452 774

Power supply: 115 / 230 V, 600 kHz

Turbo processor: 100 MHz, 200 MHz (Touch)

Scope of delivery (hf Surg Smart, hf Surg Touch, hf Surg BiPo): Device incl. foot switch, autoclavable handpiece, handpiece and electrode holder, electrode set (10 pcs.: No. 1 G, 2 A, 5 A, 11 G, 12 G, 13 G, 15 G, 31 A, 33 A, 33 G), autoclavable neutral electrode

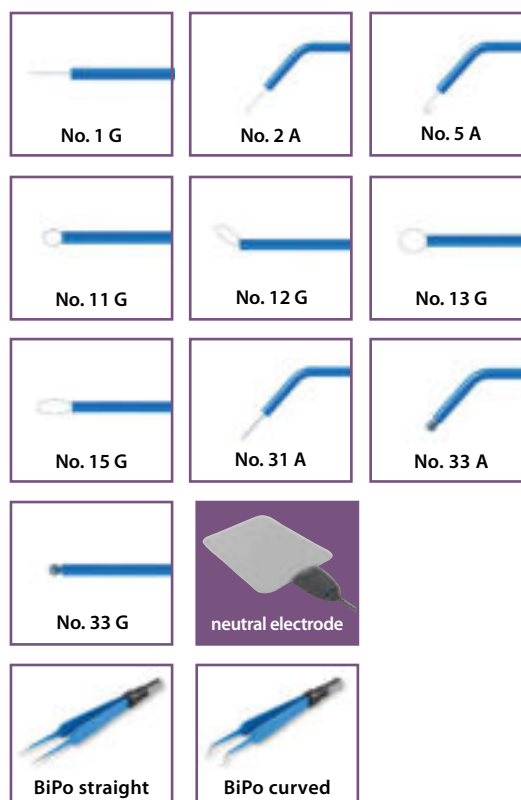

hf Electrodes for hf Surg® Plus, hf Surg® and hf1 Surg® Bipolar

Article(s)	REF
hf cutting electrode No. 1, yellow shaft	452 403
hf cutting electrode No. 2, yellow shaft	452 404
hf cutting electrode No. 12, yellow shaft	452 410
hf cutting electrode No. 13, yellow shaft	452 411
hf cutting electrode No. 14, yellow shaft	452 409
hf cutting electrode No. 15, yellow shaft	452 407
hf cutting electrode No. 17, yellow shaft	452 405
hf cutting electrode No. 22, yellow shaft	452 406
hf cutting electrode No. 23, yellow shaft	452 408
hf coagulation electrode No. 31, blue shaft	452 415
hf coagulation electrode No. 33, blue shaft	452 416
hf neutral electrode, coated plate for optimal dissipation of HF waves, length 1.50 m	452 421
hf active electrodes No. 2 A, blue shaft	452 503
hf active electrodes No. 12 G, blue shaft	452 506
hf active electrodes No. 13 G, blue shaft	452 514
hf active electrodes No. 14 A, blue shaft	452 513
hf active electrodes No. 15 A, blue shaft	452 504
hf active electrodes No. 17 A, blue shaft	452 505
hf active electrodes No. 31 A, blue shaft	452 507
hf active electrodes No. 33 A, blue shaft	452 508

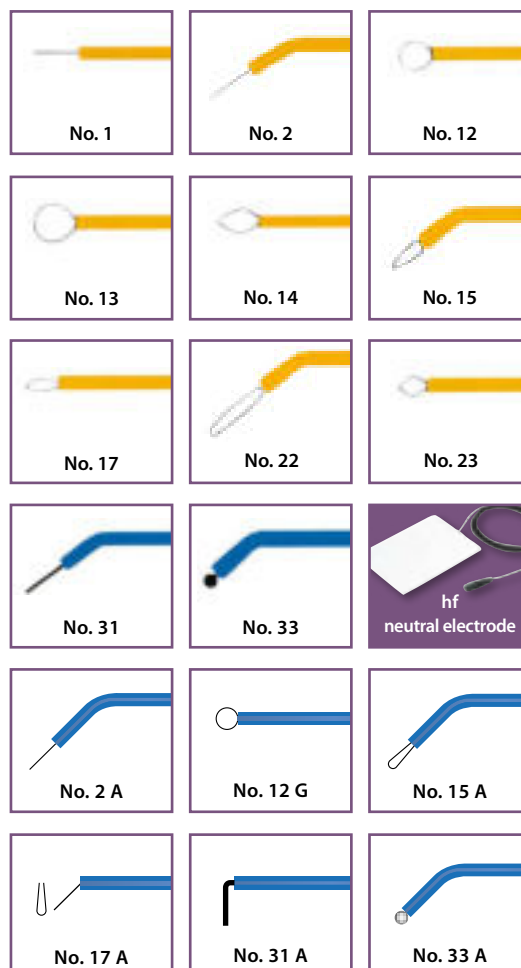

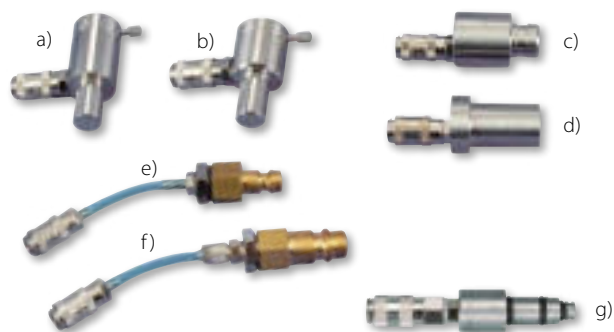

Airsonic® Adapters

Article(s)	REF
a) Adapter K for direct connection to Kavo turbine	401 084
b) Adapter S for direct connection to Sirona titan turbine	401 089
c) Connection to W+H Rotoquick	401 077
d) Bien Air Unifix	401 076
e) Connection to EMS-Box	401 090
f) Connection to lab coupling	401 091
g) Adapter for direct connection to NSK	401 075



hf Bipolar-Forceps

Special forceps connection for the hf1 Surg device only

- Available in two lengths and shapes, without cable, can be sterilized
- Ideal for surgical dentists, e.g. in achieving hemostasis

Please note: The HF bipolar cable must be ordered separately for initial setup. Not included.

Article(s)	Form of Delivery	REF
hf Bipolar-Forceps	110 mm straight	452 446
hf Bipolar-Forceps	110 mm angulated	452 447
hf Bipolar-Forceps	160 mm straight	452 448
hf Bipolar-Forceps	160 mm angulated	452 455
hf Bipolar-Kabel	1.50 m	452 456

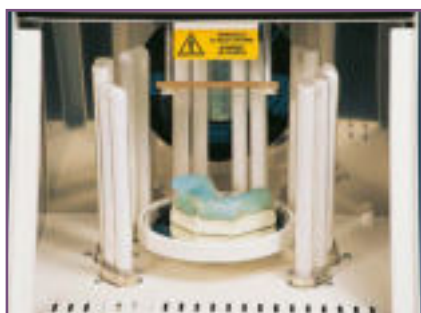

Speed Labolight®

Universal light polymerization device

- For a variety of light-curing dental resins
- Nanometer range 320 – 550 nm
- Optimized light mix for homogeneous and reliable curing
- Circular arrangement of eight rod-shaped lights around a turntable and one halogen lamp
- Interval turntable for uniform light exposure and curing
- Adjustable from one second to 99 minutes, overheating protection, polymerization temperature in the chamber does not exceed 40 °C
- Long-life, easily replaceable lamps (approx. 1,000 hours)

Technical data	Size and weight
Supply voltage: 230 V, 50 Hz	(W x H x D): 25 x 29 x 24 cm
Power consumption: 225 W	Weight: 7 kg
Fuse: 1 x 2.5 A	Turntable: ø 14 cm
Lamps:	8 x 9 W / 52 T1 (white light)
	4 x 9 W / PLS-10 T8 (UV-A)
	1 x 150 W (halogen)

Article(s)	REF
Device and 13 lamps	401 125

Replacement lamps, separately

T1 (white light) 9W / 52	901 002
T8 (UV-A) 9W / PLS-10	901 003
Halogen 150 W	901 004
Set (4 x T1 + T8, 1 x halogen)	901 001



Airsonic® Mini Sandblaster

Handy sandblaster

- For roughening the bonding surfaces of crowns, bridges, brackets, pins, etc.
- Thoroughly roughens bonding surfaces for optimal adhesion of various materials, ideal for all metals and ceramics
- Also suitable for removing cement residue from crowns and bridges
- Optional: Adapter for air connection

Article(s)	REF
Sandblaster, standard nozzle 60° and 20 g powder (50 µm)	401 080
Nozzle 60° separately	401 086

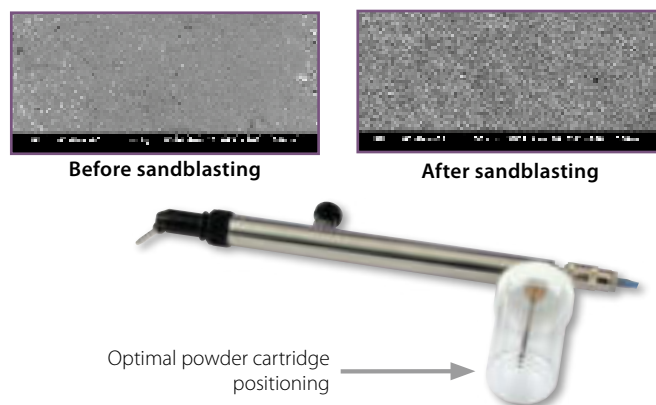

Airsonic® Absorbo Box®

Handy absorber box

- Portable absorber box – abrasive remains in the box and is completely collected in the filter
- Very quiet and powerful device
- Robust and durable construction
- Easy to clean with removable filter
- No separate exhaust system required
- Ideal for dental offices and dental laboratories in combination with the Airsonic Mini Sandblaster (REF 401 080)

Technical data:

Dimensions (W x H x D): 35.6 cm x 22 cm x 37 cm Weight: only 2.8 kg

Article(s)	REF
Airsonic Absorbo Box	401 082
Replacement filter separately	401 092
Replacement pane available on request	



Airsonic® Absorbo Box® II

Mobile aspirator

- Blasting material remains in the box and is completely collected in the filter
- Very quiet and powerful
- Easy filter change (REF 401092)
- Internal and external aspiration possible
- Large-area LED lighting
- Removable storage tray

Technical data: Dimensions (W x H x D): 36 x 30 x 38.5 cm Weight: 4.3 kg

Article(s)	REF
Airsonic Absorbo Box II	401 105





Algimix®

Alginat mixing device

- Minimal time required
- Electronically controlled, even stirring
- Mixes powder and liquid into a homogeneous, bubble-free alginate mass
- Two speeds adjustable

Technical data

Voltage:	230 V
Power consumption:	100 W
Fuse:	1.25 A
Dimension incl. bowl (W x H x D):	13.5 x 23 x 20 cm
Weight with (without) bowl:	3.7 kg (3.5 kg)

Article(s)	REF
Device with bowl and spatula	452 045
Spatula separately	304 317
Mixing bowl separately	452 047



Praxipol PS II

Pressure polymerization vessel

- Approximately 6 liter capacity
- For hot and cold polymerization
- Includes inlet valve, pressure gauge and safety valve (GS-TUV-approved)
- Provided with a non-stick coating inside to prevent corrosion

Article(s)	REF
Praxipol PS II	401 450
Additional hose with coupling, 2 m	401 401



Mirator 2000E

Electronic vibrating table

- 3,000 vibrations / min.
- Vibration intensity adjustable with arrow keys (1 – 9)
- Sturdy and powerful

Technical data

Vibration table:	Internal dimension 13 x 15 cm; available separately upon request
Voltage:	230 V – 50/60 Hz
Power consumption:	max. 200 W
Safety fuse:	2A
Weight:	3.5 kg
Vibration weight:	max. 2 – 3 kg

Article(s)	REF
Mirator 2000E	401 350

Bravo Portable II

Powerful, portable micro motor

- Allows you to work without wall socket, ideal for home visits
- Infinitely variable motor with forward and reverse operation (0 – 25,000 rpm)
- Rechargeable, long-lasting battery, charging time 6 hours and up to 8 hours of use
- Suitable for any standard hand and contra-angles piece with plane shaft (not included in delivery) without intra-spray and without light conductor; for extraoral use
- Can be attached to belt, saves space

Article(s)	REF
Bravo Portable II with belt bag and recharger	452 102

Straight and contra-angle handpieces can be found on page 85



Weight 300 g

Bravo Portable II Plus

Powerful, portable micromotor

- Allows you to work without wall socket, ideal for home visits
- Infinitely variable motor with forward and reverse operation (0 – 30,000 rpm)
- Rechargeable, long-lasting battery, charging time 3 hours and up to 8 hours of use
- Suitable for any standard hand and contra-angles piece with plane shaft (not included in delivery) without intra-spray and without light conductor; for extraoral use
- Can be attached to belt, saves space

Article(s)	REF
Bravo Portable II Plus incl. clip, handpiece tray, charger, and foot pedal	452 125



Speedo-Clean

Very gentle denture cleaning device

- Aesthetic surface cleaning using rotating polishing needles in combination with a cleaning liquid – no material abrasion
- Integrated timer for individual cleaning times
- Additional magnet holds the needles in the container during liquid change
- Autoclavable container

Technical data

Weight:	2 kg	Frequency:	50/60 Hz
Output:	35 W	Rotation:	1,700 rpm
Voltage:	230 V		

Article(s)	REF
Gerät Devie with container, 50 g polishing needles (ø 0.6 mm) 1 liter of liquid and 1 magnet	401 136
50 g polishing needles, nickel-free stainless steel ø 0.6 mm for dentures	304 014
Speedo-Clean Liquid, 1 liter	554 106
Container with lid	355 419
Magnet separately	304 012



Integra® Cart Smart

Low priced model

- Two universal electrical sockets
- Trays with rim protection
- Maximum load per tray 10 kg
- With spiral cable power connection
- Color: white (RAL 9003)

Dimensions (W x H x D): 35 x 78 x 45 cm Weight: 14.5 kg

Article(s)	REF
Integra Cart Smart	460 120



Integra Cart Smart



Back

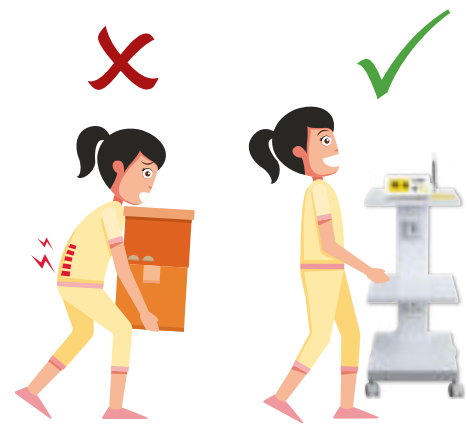

Integra® Cart De Luxe II

Multifunctional cart

- With compressed air supply
- Two universal electrical sockets
- Upper tray with additional material drawer
- With spiral cable power connection
- Easy-running castor wheels
- Lockable front castors

Dimensions (W x H x D): 77 x 35 x 45.5 cm Weight: 17.8 kg

Article(s)	REF
Integra Cart De Luxe II	460 116
Integra Cart De Luxe III (Not illustrated, with 2 drawers, 3 sockets, 21.4 kg)	460 117



Integra Cart De Luxe II



Back



Integra Cart De Luxe III



Back

Integra® Cart Attachment Tray

Tray for the column of surgery lamp

- Suitable for all accessory devices (e. g. hf Surg), which are needed chairside
- Rotatable by two swivel-joints
- Handle mountable on long or short side
- Elegant and easy to mount to all columns
- Solid metal tray, max. load 6 kg
- Color: off-white (RAL 9002)

Dimensions: Outside (W x D): 35 x 26 cm, Inside (W x D): 33.5 x 24.5 cm
Swivel arm: 23 cm long

Article(s)	REF
Integra Cart Fit-On Tray with standard arm	460 103

The Fit-On Tray has to be ordered together with the fitting pipe flange to allow for mounting.

Pipe flange incl. internal ring	ø	REF
for Planmeca	42 mm	460 104
for Ritter	48 mm	460 106
for Eurodent	50 mm	460 107
for Sirona/Siemens*	52 mm	460 108
for Kavo/Flex Integral	55 mm	460 109
for Ultradent/Faro	60 mm	460 110
for other units	45 mm	460 105

*not for Sirona Teneo/Sinus – available on request



Delivery without device



Glas Bead Heater

Device for heating up instruments

- For fog-free mouth mirrors and warming instruments before treatment
- Not suitable for sterilizing instruments
- Special heating element heats glass beads to 230 °C and keeps a constant temperature without heating up the exterior of the device
- Dimensions (W x H x D): 140 x 130 x 190 mm, chamber ø 50 mm

Article(s)	REF
Glas Bead Heater incl. 200 g glas beads	452 303
Glass bead refill pack, 200 g	452 304





Xylitol Chewing Gum

Sugar-free chewing gum with xylitol

- 100% sweetened with xylitol
- Free of aspartame, sorbitol, lactose
- Contributes to tooth mineralization*
- Reduces the risk of tooth decay in children***
- Reduces plaque**
- Promotion acrylic display available on request

Reclosable tube with 30 gums / 30 g



Article(s)	Content(s)	REF
Spearmint	30 pcs.	630 079
Peppermint	30 pcs.	630 080
Cranberry	30 pcs.	630 090
Fresh Fruit	30 pcs.	630 082
Cinnamon	30 pcs.	630 081
Watermelon	30 pcs.	630 225
Apple	30 pcs.	630 192
Strawberry	30 pcs.	630 193
Display, assorted	6 x 12 tubes	635 092

Dispenser box with 200 packs of 2 dragées individually packed

Dispenser box, chewing gums, assorted	200 pcs.	635 069
---------------------------------------	----------	---------

Bag of 100 pieces of 2 dragées individually packed

Spearmint	100 pcs.	630 114
Peppermint	100 pcs.	630 088
Cranberry	100 pcs.	630 116
Fresh Fruit	100 pcs.	630 089
Cinnamon	100 pcs.	630 115
Watermelon	100 pcs.	630 227
Apple	100 pcs.	630 235
Strawberry	100 pcs.	630 236



Xylitol Drops

Sugar-free drops with sweeteners

- Sweetened with xylitol
- Contributes to tooth mineralization*
- Without aspartame, sorbitol, lactose
- Gluten-free
- Cool, refreshing taste

Article(s)	Content(s)	REF
Xylitol Drops Melon	60 g / 26 pcs.	630 170
Xylitol Drops Cherry	60 g / 26 pcs.	630 171
Xylitol Drops Mint	60 g / 26 pcs.	630 172

Dispenser box with 100 drops – individually packed

Dispenser box Drops, assorted	100 Drops	635 183
-------------------------------	-----------	---------



From the practice for the practice

Dear Dental Practitioners, our miradent products are available through the dental dealers, but also in pharmacy, so interested patients can easily purchase them. Of course, the miradent products also represent an ideal complement to the range of your prophylaxis shop. Detailed information on our products can also be found here: www.miradent.de



XyliPOP®

Sugar-free lollipop with sweeteners

- With xylitol and calcium lactate
- Contributes to tooth mineralization*
- Free of aspartame, sorbitol, lactose
- Also great for adults
- Fruity-refreshing strawberry, blueberry or banana flavor



Article(s)	Content(s)	REF
Lollipop Strawberry	6 g	630 208
Lollipop Strawberry	Bonbonnière with 25 x 6 g	635 213
Lollipop Strawberry	Box with 50 x 6 g	635 214
Lollipop Blueberry	6 g	630 219
Lollipop Blueberry	Bonbonnière with 25 x 6 g	635 236
Lollipop Blueberry	Box with 50 x 6 g	635 231
Lollipop Banana	6 g	630 230
Lollipop Banana	Bonbonnière with 25 x 6 g	635 252
Lollipop Banana	Box with 50 x 6 g	635 251



* Consuming food that contains xylitol instead of sugar helps maintain tooth mineralization. Please pay attention to a balanced and varied diet and a healthy lifestyle. Notes: Excessive consumption may have laxative effects. Not for children under three years (risk of suffocation if swallowed). Life-threatening for pets.

Nutritional information see page 73

XYLIMED® Nasal spray + drops

Xylitol active formula with mineral salt

- Fast relief
- Non-habit forming
- Only natural ingredients



Article(s)	Content(s)	REF
XYLIMED Nasal spray	45 ml	630 184
XYLIMED Nasal drops for children	22 ml	630 185



FOR CHILDREN



Plaque staining makes a PTC up to 3 times more effective!



Mira-2-Ton®

Plaque disclosing

- Older plaque turns blue, newer plaque turns pink
- Proven in the dental office for over 30 years
- Motivating quality control for dental assistant and patient
- Erythrosine- and gluten-free
- Discoloration can be removed by toothbrushing

Mira-2-Ton® Solution

Plaque disclosing solution

Article(s)	Content(s)	REF
Mira-2-Ton Solution	10 ml	605 659
Mira-2-Ton Solution Display	12 x 10 ml	605 660
Mira-2-Ton Solution	60 ml	605 655
Mira-2-Ton Pellets (not illustrated)	250 pcs.	605 662

Mira-2-Ton® Tablets

Plaque disclosing tablets

Article(s)	Content(s)	REF
Mira-2-Ton Tablets	6 pcs.	630 027
Mira-2-Ton Tablets	5 x 10 pcs.	605 765
Mira-2-Ton Tablets	250 St. (loose)	605 768
Mouth Mirror (ø 23 mm) separately	blue transp.	630 065

Plaque Check

- Contains three plaque test tablets and one mouth mirror (with anti-fog coating) for self-control

Article(s)	REF
Plaque Check with blue mirror	630 044
Mouth mirror (not illustrated)	630 065



Plaque Agent

Find a plaque disclosing liquid for children on page 68



SOS Zahnbox®

Rescue box for dental accidents

- Transport box for knocked-out teeth and tooth fragments
- Safe and clean way to store a knocked-out tooth or tooth fragment
- Special nutrient solution increases the chance of successful replantation
- Maintaining a concentration gradient - cells of the periodontal ligament (desmodontium) remain intact until replantation

Article(s)	REF
SOS Zahnbox	630 125

Pic-Brush® Set

Interdental brush holder with one brush

- Connector system with conical neck for a safe fit
- Ergonomically shaped handle with 120° angle
- Flexible high-quality brushes, coated special wire, ultra-fine bristles
- Protection against injuries due to elaborate loop technique of wire end
- Holder end with storage compartment and clip-on function
- Also for cleaning of brackets, bridges and dentures

Article(s)	REF
Holder transparent blue with 1 brush	630 002
Holder transparent pink with 1 brush	630 003
Holder yellow with 1 brush	605 630

Pic-Brush® Intro Kit

Interdental brush holder with four brushes in four thicknesses

Article(s)	REF
Holder transparent blue with 4 brushes	630 005
Holder transparent pink with 4 brushes	630 006
Holder yellow with 4 brushes	605 728

Pic-Brush® Replacement Brushes

Article(s)	Content(s)	REF
Replacement brushes, pink	6 pcs.	630 013
	25 pcs.	607 060
Replacement brushes, yellow	6 pcs.	630 014
	25 pcs.	607 061
Replacement brushes, white	6 pcs.	630 015
	25 pcs.	607062
Replacement brushes, green	6 pcs.	630 016
	25 pcs.	607 063
Replacement brushes, blue	6 pcs.	630 017
	25 pcs.	607 064
Replacement brushes, bordeaux	6 pcs.	630 050
	25 pcs.	607 065
Replacement brushes, orange	6 pcs.	630 018
	25 pcs.	607 066

Optional 12-pack available upon request

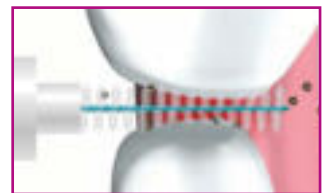
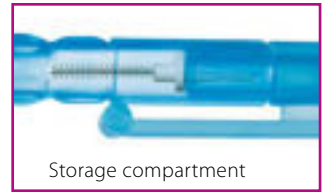

I-Prox® L

Pocket size interdental brushes

- Extended L-shaped handle and 100° angle for easy handling
- Hygienic protective cap, ideal for on the go
- Six sizes from xx-fine to large, color-coded

Article(s)	Content(s)	REF	
I-Prox L, pink	xx-fine	6 pcs.	630 210
I-Prox L, yellow	x-fine	6 pcs.	630 211
I-Prox L, white	fine	6 pcs.	630 212
I-Prox L, green	medium	6 pcs.	630 213
I-Prox L, orange	conical	6 pcs.	630 214
I-Prox L, bordeaux	large	6 pcs.	630 215
I-Prox L, assorted		6 pcs.	630 216

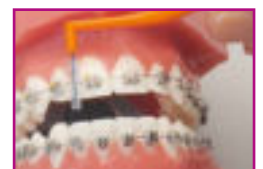

Switch-function
allows for two angles
for various applications

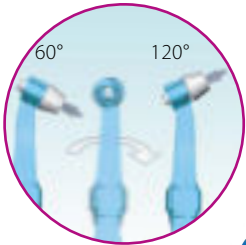

I-Prox® P

Pointed brush for precise use

- Efficient cleaning of the gingival margin and sulcular pockets thanks to conically tapered bristle tuft
- Ideal for cleaning of orthodontic appliances, implants and interdental spaces
- Optimal application of preparations
- Finger-grip handle (14 cm) with two click-on angles (60° and 120°)
- Holder end with storage compartment for brushes



Gingival pocket



Implants



Brackets

Article(s)	REF
Holder transparent blue incl. 4 tips	630 032
Holder transparent pink incl. 4 tips	630 033
Replacement brushes, 4 pcs.	630 034
I-Prox Care Set	630 160



Zahnpick® 2in1

Dental floss sticks for thorough cleaning of the interdental spaces

- With fine, gliding dental floss
- Developed by dentists
- Combination of dental floss and toothpick
- With mint flavor

Article(s)	Content(s)	REF
Zahnpick 2in1	40 pcs.	630 057
Zahnpick (not illustrated)	30 pcs.	630 039
Zahnpick (not illustrated)	100 pcs.	605 637

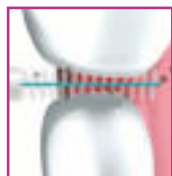

Pic-Brush® Minis

Interdental brushes

- For optimal and thorough cleaning of the interdental spaces
- Also suitable for cleaning brackets, bridges and dentures
- Elaborate loop design of the surgical stainless steel wire end prevents injury
- Ergonomic handle and flexible premium bristles allow you to easily reach molars and interdental spaces
- Ergonomic handle's soft material provides a secure grip and ease of use
- Ideal for on-the-go thanks to the resealable pressure seal bag

Article(s)	Content(s)	REF
Pic-Brush Minis, ISO 2, red	32 pcs.	630 252



Happy Morning®

Single-use toothbrush

- Hygienic toothbrushes with or without toothpaste
- Pre-treatment preparation
- Fresh breath



Happy Morning® Xylitol

Single-use toothbrush with xylitol

- Bristles are impregnated with xylitol toothpaste
- Fresh flavor
- Short head design (2.5 cm)
- Hygienically and separately packed
- Ideal when traveling, in between meals and as toothbrush for guests
- Xylitol has an anti-cariogenous effect, decreases plaque- and acidforming bacteria



After meals



In the office



When travelling



Before a date



Happy Morning® Bamboo

Single-use toothbrushes made from renewable resources

- Climate-neutral bamboo handle (100% biodegradable)
- Bamboo has an antibacterial and antimicrobial effect
- Bristles impregnated with toothpaste containing xylitol
- Short brush head (2.5 cm)
- Hygienically individually packaged (PLA film is biodegradable)



Happy Morning® De Luxe

Toothbrush with even bristle field

- Rounded bristles and angled handle
- Medium bristle thickness
- Hygienic, individually packaged



Happy Morning® Travel Kit

Dental care travel kit companion

- Toothbrush and 3 g tube with fresh mint toothpaste
- Toothbrush and tube hygienically blister-packed
- Toothbrushes in three colors, assorted



Article(s)	Content(s)	REF
Happy Morning with toothpaste	100 pcs.	605 401
Happy Morning without toothpaste	100 pcs.	605 403
Happy Morning Xylitol	50 pcs.	605 496
Happy Morning Bamboo	40 pcs.	605 426
Happy Morning De Luxe	50 pcs.	605 443
Happy Morning Travel Kit	50 pcs.	605 410



Dosing pump

For the best possible dosage of the mouth rinse



paroguard®

Patient-friendly pre-procedural mouth rinse

- To be used before each prophylaxis appointment
- Remineralizing due to fluoride (250 ppm)
- Especially for use with limited oral hygiene ability
- Astringent due to hamamelis, anticariogenic due to xylitol
- Alcohol-free

Article(s)	Content(s)	REF
paroguard	200 ml	630 087
paroguard (pump not included)	5000 ml	630 127
Dosing pump separately		630 138

mirafluor® chx

Mouth rinse with chx 0.06 %

- For daily use, includes dosing cap
- Remineralizing due to fluoride (250 ppm)
- Astringent due to hamamelis
- Anti-cariogenic due to xylitol
- Alcohol-free
- Supports daily oral care thanks to chlorhexidine gluconate (0.06 %)

Article(s)	Content(s)	REF
mirafluor chx 0.06 %	100 ml	630 085
mirafluor chx 0.06 %	500 ml	630 086



Plaque Agent®

Plaque disclosing liquid

- Existing plaque is revealed in blue
- Pleasant "bubble gum" flavor
- Ready-to-use, motivational, child-friendly
- Coloring can be easily removed by brushing teeth
- Directions for use: 1 – 2 x daily 10 ml, rinse for approx. 30 sec. before brushing teeth
- Erythrosine-free, alcohol-free
- Incl. dosing cap

Directions for use:
1 – 2 x daily 10 ml,
rinse for approx.
30 sec. before
brushing teeth

Article(s)	Content(s)	REF
Plaque Agent	250 ml	630 186
Plaque Agent	500 ml	630 126



Tooth necks are exposed

Apply gel

Tooth necks are protected

Mirasensitive Pen hap+

Desensitising pen with hap

- Rapid reduction of sensitivity to pain
- Forms natural analogue enamel (hap)
- Precise application / treatment

Article(s)	REF
Mirasensitive Pen hap+	630 313



Mirawhite® shine

Effective tooth whitening even in sensitive teeth

- Pen for hygienic application
- Tooth whitening with active-oxygen
- Free of peroxide
- Gentle on enamel and gingiva
- Does not soften fillings
- Tooth whitening by up to five shades

Article(s)	Content(s)	REF
Mirawhite shine	1,8 ml	630 194



Ablagerung



Auftragen

Mirafluor® Kids

Toothpaste for children (0 – 6 years)

- Cleans milk teeth and gums
- Protection against tooth decay with fluoride and Xylitol
- Special tube opening protects against increased fluoride absorption
- Refreshing raspberry flavor
- Contains sodium fluoride (1,000 ppm)

Article(s)	Content(s)	REF
Mirafluor Kids	75 ml	630 224



Child-friendly, rice grain-sized dosage possible

Mirafluor® C

Standard fluoride toothpaste

- Cleans teeth and gums
- Mild mint flavor
- Sodium fluoride (1,450 ppm)

Mentha Arvensis – field mint



Toothpaste with fluoride



Fluoride enrichment can prevent plaque

Article(s)	Content(s)	REF
Mirafluor C	100 ml	630 083



mirasensitive hap+®

Intensive care for the protection of sensitive teeth

- Sealing of open tubules
- 30% hydroxyapatite builds up biomimetic enamel
- Potassium ions calm the tooth nerve
- Daily treatment to protect teeth from painful stimuli
- Contains fluoride and Xylitol to prevent tooth decay and tooth neck decay
- Mild and fresh taste
- RDA-value: 30
- Sodium fluoride (1,450 ppm)



Open dentin tubules lead to stimulus responses



Closed dental tubules

● Potassium ions ● Hydroxyapatite

Article(s)	Content(s)	REF
mirasensitive hap+	50 ml	630 169





Mirawhite® gelée

Intensive cleaning for shiny white teeth

- Immediate illuminating effect
- Restores natural tooth whiteness
- Innovative multiple-effectiveness
- Xylitol and sodium fluoride (1,450 ppm) prevent tooth decay

Article(s)	Content(s)	REF
Mirawhite gelée	100 ml	630 123

OXYSAFE® PRO₂

Toothpaste with active oxygen

- Excellent protection for teeth and gums
- With xylitol
- Revitalizing
- For healthy gums and pearly-white teeth
- With sodium fluoride (1450 ppm)
- Free of alcohol



Article(s)	Content(s)	REF
OXYSAFE PRO2	75 ml	630 166

OXYSAFE® Active^{+F}

Mouthwash with active oxygen

- Supports treatment of periodontitis with 7-fold protection
- Protects against tooth decay, reduces plaque, and strengthens gums and enamel
- For extra white teeth, fights bacteria and freshens breath
- Contains sodium fluoride (450 ppm)



Article(s)	Content(s)	REF
OXYSAFE Active+F	500 ml	630 311

halitosis spray

Oral care spray for immediate fresh breath

- Eliminates mouth odor (halitosis)
- Dental care properties due to added Xylitol (10 %)
- Alcohol-free



Article(s)	Content(s)	REF
halitosis spray	15 ml	630 168

AQUAMED® Lozenges

AQUAMED® Spray

For the support of saliva production

- Contributes to tooth mineralization*
- Sweetened with xylitol
- Refreshing passion fruit flavor

Article(s)	Content(s)	REF
AQUAMED Lozenges, 26 pcs.	60 g	630 164
AQUAMED spray	30 ml	630 218



AQUAMED® Gel

Reduces dry mouth

- For the daily oral hygiene
- Intensive and long-lasting oral moisturization
- Contains the holy herb (Yerba Santa)
- Stimulates saliva flow
- Contains the protective enzyme lysozyme

Article(s)	Content(s)	REF
AQUAMED Gel	100 ml	630 229



AQUAMED® Chewing Gum

Dental care chewing gum

- Helps to reduce dry mouth*
- Reduces plaque**
- Refreshing passion fruit flavor

Article(s)	Content(s)	REF
AQUAMED Chewing Gum tube	30 pcs. / 30 g	630 223



AQUAMED® Strips

Saliva stimulation strips

- Reduces dry mouth
- With hyaluronan
- With biotin and vitamin B2
- Ideal for on-the-go
- Pleasant lemony mint flavour

Article(s)	Content(s)	REF
AQUAMED Strips	24 pcs. / 1.44 g	630 312





Tong-Clin® De Luxe

Tongue cleaner

- Dual function in one instrument:
 - Bristle field with short, rounded bristles lifts off tongue coatings
 - Tongue scraper removes the loosened coatings subsequently
- Angled, flat arched top reduces gag reflex
- Ergonomic finger-grip handle with protective cap

Article(s)	Content(s)	REF
Tong-Clin De Luxe, transparent blue		630 029
Tong-Clin De Luxe, transparent pink		630 030
Tong-Clin De Luxe, blue		605 778
Tong-Clin Fresh	15 ml gel	630 179
Tong-Clin Set (not illustrated)	50 ml gel	630 060
Tong-Clin Gel (not illustrated)		630 059



Mirafloss®

Dental floss / tape

- For specially thorough cleaning of interdental spaces
- Extremely tear-proof, does not fray
- Tape: not waxed, glides perfectly through even the narrowest interdental spaces

Article(s)	Content(s)	REF
Mirafloss Tape	20 m	630 022
Mirafloss unwaxed dental floss	20 m	630 077



Mirafloss® Implant

Floss fibers from the roll

- Floss fibers (15 cm each) rolled up in a handy dispenser
- Stiff ends facilitate threading
- Ideal for the cleaning of implants and bridges
- Available in two thicknesses: fine (ø 1.8 mm), medium (ø 2.2 mm)

Article(s)	Content(s)	REF
fine (pink)	45 pcs.	630 187
medium (turquoise)	20 pcs.	630 188



Mirafloss® Big

Wall-mountable dispensing box

- Ideal for professional use in practice
- One-handed operation using sharp metal edge

Article(s)	Content(s)	REF
Mirafloss Big (white, waxed / black, waxed, mint)	2 x 200 m	605 735
Refills: black, waxed, mint	200 m	605 737
Refills: white, waxed	200 m	605 736
Refills: white, unwaxed	200 m	605 738

Infant-O-Brush®

Training toothbrush integrated in a teething ring

- Teaches regular dental care in a playful way
- Teething ring with extra soft bristle part
- Bumps on the rubber ring enhance teething
- Oval shape eliminates risk of choking and injury
- For infants 3 months and older



Bristle field

For a gentle massage of the gums and cleaning of the first milk teeth.



Teething ring

The handle, which also acts as a teething ring, promotes tooth eruption with the special nubs.

Article(s)	REF
Infant-O-Brush, red	630 026
Infant-O-Brush, yellow	605 617

Funny Animals

Hygienic toothbrush holder

- Easy snapping in place and removal of toothbrush
- Patented snap lock
- Ventilation slots ensure an ideal air exchange
- Fitting for any off-the-shelf toothbrush – for children aged 3 years and older



Article(s)	REF
Funny Cow	630 099
Funny Giraffe	630 220
Funny Panda	630 222
Funny Lion	630 102
Funny Elephant	630 100
Funny Cat	630 226

Two suction cups
Can be attached to
any smooth surface



Kid's Brush

Children's Toothbrush

- Small head with oval bristle field
- Plane tuft field with soft rounded nylon bristles
- "Upper body" is hinged and protects the bristle field
- Air circulation by opening in the protective cap
- Brush handle also serves as practical stand
- For children from the age of four

Article(s)	REF
Kid's Brush Parrot (1)	630 047
Kid's Brush Duck (2)	630 046
Kid's Brush Dog (3)	630 049
Kid's Brush Bear (4)	630 048
Set, 4 pcs. assorted	605 820



* The positive effect is ensued if the chewing gum is consumed every time your mouth feels dry.
 ** Chewing gum, which is sweetened 100 % with xylitol, has been proven to reduce dental plaque. Heavy plaque is a risk factor for the development of tooth decay in children. The positive effect is ensued if 2 – 3 g of chewing gum – 100 % sweetened with xylitol – are consumed at least 3 times a day after meals.
 *** The positive effect occurs when chewing the xylitol chewing gum for at least 20 minutes after eating or drinking. (Consuming food that contains xylitol instead of sugar helps maintain tooth mineralization.)
 Notes: Chewing gum with sweetener. Excessive consumption may have laxative effects! Please pay attention to a balanced and varied diet and a healthy lifestyle. Recommended daily allowance: Adults 1 – 10 pieces. Not for children under three years (risk of suffocation if swallowed). Life-threatening for pets.

Xylipop Nutritional Information

Ingredients Xylipop Strawberry: sweetener: xylitol; stabilizer: isomalt; thickening agent: gum arabic; aroma; strawberry extract; acidity regulator: calcium lactate; acidifying agent: citric acid; separating agent: magnesium stearate; coloring agent: beetroot red. **Ingredients Xylipop Blueberry:** sweetener: xylitol; stabilizer: isomalt; thickening agent: gum arabic; aroma; malic acid; acidity regulator: calcium lactate; acidifying agent: citric acid; separating agent: magnesium stearate; coloring agent: blueberry powder. **Ingredients Xylipop Banana:** sweetener: xylitol; stabilizer: isomalt; thickening agent: gum arabic; aroma; malic acid; acidity regulator: calcium lactate; banana powder, acidifying agent: citric acid; separating agent: magnesium stearate; coloring agent: beta-carotene. **Xylipop Nutritional Information / proportion per 100 g:** calorific value 815 kJ / 195 kcal, fat 0 g, of which saturated fatty acids 0 g, carbohydrates 87 g, of which sugar 0 g, protein 0 g, salt 0 g, Filling quantity: 6 g

Aquamed Nutritional information

Ingredients aquamed chewing gum: sweetener: xylitol, gum base, flavour, acidity regulator: malic acid, colouring agent: calcium carbonate, thickening agent: gum arabic, humectant: glycerin, emulsifier: lecithin (sunflower), coating agent: carnauba wax. **Nutritional information per 100 g:** energy 744 kJ/177,6 kcal, fat 0 g, of which saturated fatty acids 0 g, carbohydrates 74 g, of which sugar 0 g, protein 0 g, salt 0 g.



Carebrush® Kids Toothbrush

For gentle cleaning of milk teeth

- For children aged 2 – 6 years
- Non-slip handle with thumb rest
- Available in pink and blue

Carebrush® Junior Toothbrush

For thorough cleaning of mixed dentition

- For children aged 6 – 12 years
- With convenient suction base
- Ergonomic, rubberized handle
- Available in pink and blue

Article(s)	REF
Carebrush Kids Toothbrush, blue	630 261
Carebrush Kids Toothbrush, pink	630 260
Carebrush Junior Toothbrush, blue	630 266
Carebrush Junior Toothbrush, pink	630 265



Carebrush® white

Toothbrush with “whitening effect”

- Brush head with special rubber lamellas cleans thoroughly, while providing a natural tooth whitening effect
- Spiral-shaped bristles on the front of the brush head improve access to hard-to-reach areas
- Criss-cross bristles help clean thoroughly between teeth
- Anatomical “non-slip” handle



Carebrush® supersoft

Toothbrush with silky-soft micro bristles

- Silky-soft bristles for hypersensitive teeth necks and irritated gums (e.g. in periodontitis) and for dental care following prophylaxis treatments
- Gentle and thorough cleaning with minimal enamel abrasion
- Tongue scraper on the back of the brush head
- Non-slip handle



Carebrush® ortho

Toothbrush for fixed braces

- Toothbrush with V-shaped bristles for cleaning fixed braces
- For the cleaning brackets and other orthodontic works
- V-shaped bristle field for an effective bracket cleaning
- Soft inner bristles and firmer outer bristles
- Long, slender neck for easy access to hard-to-reach areas

Article(s)	REF
Carebrush white, green	630 190
Carebrush white, pink	630 191
Carebrush supersoft	630 195
Carebrush ortho	630 196



miradent® Hourglass

Child-friendly hourglass as timer for tooth brushing

- Ideal for observing the recommended minimum brushing time
- Runs for 2 minutes
- Suction cup attaches to any smooth surface

Article(s)	REF
miradent Hourglass	630 068



Dento-Box® I

Solid transport and storage box

- For dentures, orthodontic work etc.
- Impact-resistant, secure snap closure and with small ventilation holes
- With trendy cord

Article(s)	REF
Dento-Box I, white	630 162
Dento-Box I, blue	630 161
Dento-Box I, pink	630 163



See page 26 for Dento-Box without cord

Protho Brush® De Luxe

Denture toothbrush

- With two brush heads: large bristle field for cleaning the outside of the denture, smaller head for cleaning the inside of the denture
- Ergonomic finger-shaped handle

Article(s)	REF
Protho Brush De Luxe, transparent blue	630 024
Protho Brush De Luxe, transparent pink	630 025
Protho Brush De Luxe, blue	605 413



Protho® Box

Waterproof lockable box for dental prostheses

- For storing and cleaning dentures
- Waterproof due to special locking
- Holds 2 dentures and approx. 80 ml of liquid
- Also suitable for storing removable braces
- Box contains double-sided cleaning brush, white bristles for basic surfaces, black bristles for denture recesses
- Brush compartment also suitable for cleaning tablets
- With mirror in the lid

Article(s)	REF
Box with brush	605 900
Brush separately	605 901



Dimensions (W x H x D):
11.5 x 4.5 x 8.5 cm



Mara® Expert Paromed Toothpaste

- With 67% mineral salt and botanical extracts
- Prevents gum bleeding
- For healthy oral flora

Article(s)	Content(s)	REF
Mara Expert Paromed Toothpaste	75 ml	MARAE01



Mara® Expert Toothbrush 6580 Ultra X Toothbrush

- With 6580 filaments
- Ergonomic handle
- 20% less plastic

Article(s)	Content(s)	REF
Toothbrush 6580, Assortment, assorted	6 x 2 pcs.	MARAE05



Mara® Expert Protector Fluorid Gelee

- Intensive protection against tooth decay – 1 x per week
- Strengthens tooth enamel
- Remineralization
- Treatment of hypersensitive tooth necks

Article(s)	Content(s)	REF
Mara Expert Protector Fluorid Gelee	25 ml	MAPRO01



Mara® Expert Floss STX dental floss sticks

- Extra strong
- Tear-resistant
- For very narrow interdental spaces



Article(s)	Content(s)	REF
Mara Expert Floss STX dental floss sticks	30 pcs.	MARAZS02

Mara® Expert Premium Interdental Brushes

- Soft premium bristles coated with fluoride, CHX and mint flavour
- Plastic-coated, medical stainless steel wire
- Hygienic protective cap, also serves as handle extension
- Soft handle for a secure hold, colour-coded in accordance with ISO norm

Each brush with protective cap!



12 pcs.



100 pcs.

Article(s)	ISO	Ø Wire	Passage Hole Diameter	Content(s)	REF
Mara Expert "Premium Line", pink	ISO 0 (extra fine)	0.4 mm	< 0,6 mm	12 pcs.	MARAID00
Mara Expert "Premium Line", orange	ISO 1 (fine)	0.45 mm	0.7 – 0.8 mm	12 pcs.	MARAID01
Mara Expert "Premium Line", red	ISO 2 (medium fine)	0.5 mm	0.9 – 1.0 mm	12 pcs.	MARAID02
Mara Expert "Premium Line", blue	ISO 3 (medium)	0.6 mm	1.1 – 1.2 mm	12 pcs.	MARAID03
Mara Expert "Premium Line", yellow	ISO 4 (medium wide)	0.7 mm	1.3 – 1.5 mm	12 pcs.	MARAID04
Mara Expert "Premium Line", green	ISO 5 (wide)	0.8 mm	1.6 – 1.8 mm	12 pcs.	MARAID05

Article(s)	ISO	Ø Wire	Passage Hole Diameter	Content(s)	REF
Mara Expert "Premium Line", pink	ISO 0 (extra fine)	0.4 mm	< 0,6 mm	100 pcs.	MARAIDZ0
Mara Expert "Premium Line", orange	ISO 1 (fine)	0.45 mm	0.7 – 0.8 mm	100 pcs.	MARAIDZ1
Mara Expert "Premium Line", red	ISO 2 (medium fine)	0.5 mm	0.9 – 1.0 mm	100 pcs.	MARAIDZ2
Mara Expert "Premium Line", blue	ISO 3 (medium)	0.6 mm	1.1 – 1.2 mm	100 pcs.	MARAIDZ3
Mara Expert "Premium Line", yellow	ISO 4 (medium wide)	0.7 mm	1.3 – 1.5 mm	100 pcs.	MARAIDZ4
Mara Expert "Premium Line", green	ISO 5 (wide)	0.8 mm	1.6 – 1.8 mm	100 pcs.	MARAIDZ5



Putzi-Tiere

Hand puppets with denture

- Ideal motivational tool for children
- To explain proper dental care
- Special gimmick: with integrated water pistol
- Approx. dimensions W x H x D: approx. 17 cm x 28 cm x 15 cm

Article(s)	REF
Putzi Horse (1)	707 048
Putzi Dino (2)	707 046
Putzi Dragon (3) (no hand puppet)	707 100
Putzi Crocodile (4)	707 045



Miratoi® No. 1

Mixed assortment

- Cars, boats, combs, etc.

Article(s)	Content(s)	REF
Mixed assortment, assorted	150 pcs.	605 690



Miratoi® No. 3

Farm Set

- Various farm animals



Article(s)	Content(s)	REF
Farm Set, assorted	100 pcs.	605 692



Miratoi® No. 4

Zoo Set

- Various zoo animals



Article(s)	Content(s)	REF
Zoo Set, assorted	100 pcs.	605 693

FUN & PRACTICAL

Miratoi® No. 6

Finger rings

- Lovely finger rings in various sizes



Article(s)	Content(s)	REF
Finger rings, assorted	100 pcs.	605 694

Miratoi® No. 7

Watches

- Puzzle in the shape of watches in various colors



Article(s)	Content(s)	REF
Watches, assorted	80 pcs.	605 695

Miratoi® No. 8

Bouncy balls

- Funny bouncy balls in various colors
- ø 2.5 cm



Article(s)	Content(s)	REF
Bouncy balls, assorted	100 pcs.	605 696

Miratoi® No. 10

Miniature cars and boats

- Miniature cars and boats in various colors



Article(s)	Content(s)	REF
Miniature cars and boats, assorted	100 pcs.	605 698

Miratoi® No. 13

Treasure chests

- Ideal for the safekeeping of deciduous teeth

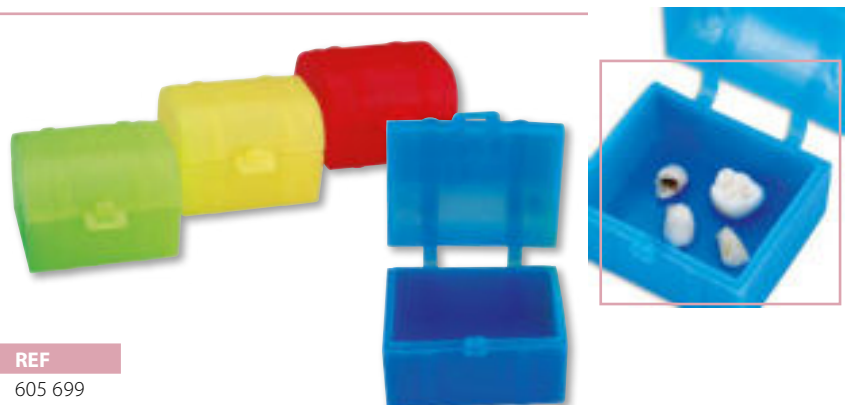

Article(s)	Content(s)	REF
Treasure chests, assorted	100 pcs.	605 699



Miratoi® No. 14

Wind-up chattering teeth

- Great fun for young and old patients
- Fun look with attached eyes
- Simply wind it up and it starts chattering

Article(s)	Content(s)	REF
Wind-up chattering teeth	24 pcs.	221 813



Miratoi® No. 15

Mini ponies

- For combing and cuddling
- In five colors



Article(s)	Content(s)	REF
Mini ponies, assorted	50 pcs.	605 701



Miratoi® No. 17

Fingerboards

- In 5 cool designs
- Ultimate fingerboards in different styles



Article(s)	Content(s)	REF
Fingerboards, assorted	48 pcs.	605 702



Miratoi® No. 19

Snap-on bracelets

- Reflecting bracelets increase the visibility in the dark
- Snap-on bracelets automatically bend under slight pressure and adjust to any wrist girth
- Well suited for cyclists and joggers
- Size (L x W): 21 x 2.5 cm

Article(s)	Content(s)	REF
Snap-on bracelets	50 pcs.	605 702

FUN & PRACTICAL

Miratoi® No. 20

Glider for brave patients

- Glider made of polystyrene
- 5 different versions
- Glides through the air effortlessly, with propeller for good flying characteristics



Article(s)	Content(s)	REF
Glider for brave patients, assorted	50 pcs.	605 704

Miratoi® No. 21

Medal set

- Special award as motivation for brave young patients
- Stamped medal with ribbon
- Made of medal, ø 3.6 cm



Article(s)	Content(s)	REF
Medal set	50 pcs.	605 731

Miratoi® No. 22

Unicorn pearl bracelets

- Decorative bracelets with pearls (ø 7 mm)
- Elastic band with unicorn pendant



Article(s)	Content(s)	REF
Unicorn pearl bracelets, assorted	50 pcs.	605 741

Miratoi® No. 23

Children's stamps

- Five designs: unicorn 1, unicorn 2, giraffe, crab; lion

Article(s)	Content(s)	REF
Children's stamps, Box with 60 pcs. (5 x 12)		605 750



Tooth Coin Bank

Tooth-shaped coin bank

- Solid ceramic-like material
- Large opening, also suitable for bills
- With reclosable opening at the bottom



Article(s)	REF
Tooth Coin Bank	707 105



EASY SHINE



Protho Clean®

Fully synthetic care product for cleaning and high-gloss polishing of acrylic dentures

- Aesthetically enhances the presentation of your prosthetic work
- Removes polish and monomer residues from dentures
- Simply spray on, allow to soak in and wipe off with a soft cloth
- Pleasant mint flavor

Article(s)	Content(s)	REF
Protho Clean	75 ml	554 220



Non-Stick®

Special silicone spray

- Insulating, protective and maintenance spray
- Essential for articulator maintenance
- Allows condyles, balls and all moving parts to slide easily
- Prevents plaster from sticking to trimmers, cuvettes and rubber pads of vibrators etc.
- Makes door and appliance hinges move smoothly

Article(s)	Content(s)	REF
Non-Stick	400 ml	554 206



Mirapont® Agent Plus

- Isolates Mirapont from wax
- Polyether, polysulfite impressions against Mirapont

Article(s)	Content(s)	REF
Mirapont Agent Plus	200 ml	203 016

Mirapont® Silifit

- Special block-out material, kneadable

Article(s)	Content(s)	REF
Mirapont Silifit	250 g	203 015



Occlu® Spray Plus

High-quality, green occlusion spray

- To mark contact points by spraying directly onto the occlusal surfaces occlusal surfaces or the inside of crowns
- Micro-powder layer for highest accuracy
- Contains food coloring
- Powder layer can be easily removed with water, economical consumption

Article(s)	Content(s)	REF
Aerosol spray, green	75 ml	554 205
Aerosol spray, green	50 ml	554 211

Dipol®

Proven wetting agent for all phosphate and plaster based investment materials

- For precise, clean casting
- Degreases wax, relaxes wax surface
- Creates a molecular bridge between the hydrophobic wax and the investment, allowing it to flow over the wax object without bubbles. This results in clean, smooth casting surfaces.
- Does not contain any setting retardants or otherwise interfering chemicals that can lead to rough surfaces
- Also excellent as a wetting agent for silicone, polyether, etc. impressions for easy casting with plaster for model making
- Formaldehyde-free, alcohol-free
- Propellant-free pump spray with micro-fine mist

Article(s)	Content(s)	REF
Set with 1 l bottle + 1 pump bottle	(empty)	605 044
Pump bottle, filled	100 ml	605 043
Pump bottle	(empty) for 100 ml	605 045



Mirapor®

Insulates plaster cast

- No film formation, as it is not silicone-bound
- Precise, very easy separation
- Plaster contours detach without aid
- No discoloration of models
- Seals the plaster pores against dirt and water
- Plaster surfaces can be polished to a high gloss with a brush or cloth
- Propellant-free, formaldehyde-free

Article(s)	Content(s)	REF
Set with 1 l bottle + 1 pump bottle	(empty)	605 113
Pump bottle, filled	100 ml	605 119
Pump bottle	(empty) for 100 ml	605 114



Mirawet®

Preserving mixing liquid for all pumice powders

- Keeps the polishing compound creamy all day long
- Preservative properties
- Safe for skin contact
- Skin neutral pH
- Biodegradable and formaldehyde-free

Article(s)	Content(s)	REF
Mirawet	5 l	554 105





Alminax and Alminax Rite-Bite

Aluminum wax and preformed bite indexes

- For absolutely precise bite registration
- High percentage of aluminum keeps the sheets warm very well
- Extremely hard after cooling off

Article(s)	Content(s)	REF
Alminax	250 g 11 layers à 3 mm	101 301
Alminax Rite-Bite	2.5 mm 24 pcs. reinforced, 6 pcs. plain	101 302

Alminax Rite-Bite

Bite indexes made of preformed aluminum wax

Article(s)	Content(s)	REF
Alminax Rite-Bite	24 pcs. reinforced, 6 pcs. plain	101 302

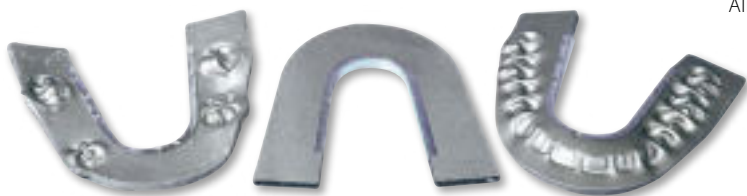

Corund SC

Firm grip on abrasive material

- In grain sizes 80 (very coarse) – 220 (very fine)
- Pointed grain remains intact for a long time and wears slowly
- On 15 mm wide rolls

Article(s)	Length	Grain	REF
Corund SC No. 80	25 m	80	605 016
Corund SC No. 100	30 m	100	605 017
Corund SC No. 120	30 m	120	605 018
Corund SC No. 150	30 m	150	605 019
Corund SC No. 180	50 m	180	605 020
Corund SC No. 220	50 m	220	605 021

Miracast

Model former



Article(s)	Size	REF
Miracast LJ small	80 x 60 x 15 mm	203 066
Miracast LJ medium	85 x 65 x 15 mm	203 067
Miracast UJ small	75 x 60 x 15 mm	203 065
Miracast UJ medium	80 x 61 x 15 mm	203 068
Miracast UJ large, fits for upper and lower impressions	100 x 80 x 15 mm	203 069

UJ = Upper Jaw, LJ = Lower Jaw

Orbatec® Prophy

Prophylaxis contra-angles

- For prophy cups and brushes with screw and button fixation
- From 0 – 5,000 rpm
- Fit any standard micro motor with plane shaft



Article(s)	REF
WST PK (button fixed)	452 152
WST PS (screw fixed)	452 153

Standard hand pieces and contra-angles

- Fit any standard micro motor with plane shaft

WST (30 BL) 30,000 rpm	452 150
HST (30 A) 40,000 rpm	452 158



Button fixation

Screw fixation

WST

HST

Mirapont®

A pale, highly precise special acrylat for stumps and models

- Very thin and low viscosity material
- Both liquids (components A and B, ratio 1:1) are mixed within 30 sec.
- Can be poured into silicone, alginate, reversible hydrocolloid and thermoplastic
- Can be sawed, milled and polished after 90 min.



Article(s)	REF
Mirapont 500 g Includes: 250 g liquid A, 250 g liquid B, 2 dosage bottles A and B, 200 ml Agent Plus, 50 g Silifit, 5 measuring cups, 1 shaker with pouring spout, 2 large mixing spatulas, 5 small mixing spatulas, disposable gloves	203 010
Mirapont 1,000 g Includes: 2 x 250 g liquid A, 2 x 250 g liquid B, 2 dosage bottles A and B, 200 ml agent plus, 50 g silifit, 5 measuring cups, 1 shaker with pouring spout, 2 large mixing spatulas, 5 small mixing spatulas, disposable gloves	203 011





Ergotherapeutic Seat Wellbeing for your back



1 Standard

2 Cutaway -
Particularly narrow curvature

3 Small -
Smallest saddle shape for
those with a small frame

4 Large -
Largest saddle shape for
those of a larger build

» Preserves the natural pelvic and spinal position when sitting

» Significantly reduces the pressure on the intervertebral discs

» **TILT ANGLE** and height of the seat adjustable



Standard

- Standard saddle shape
- Particularly popular among people with hips of average width
- Ensures a healthy and comfortable posture
- For the elimination and prevention of back pain

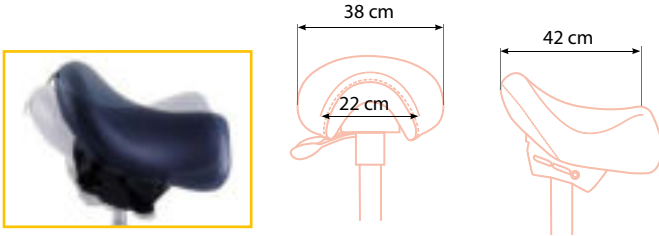

Cutaway

- Comfortable for people with narrow hips

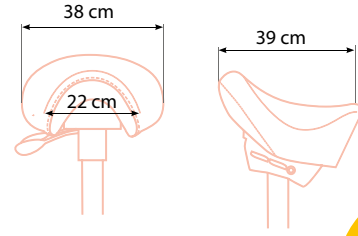

Seat height ideally matched to the appropriate body size:

Height of gaslifts	S	M	L
Body size	up to 1.60 m	up to 1.90 m	over 1.90 m

(Please consider when placing an order.)

With **NARROW** curvature!



Article(s)	Color	REF
Bestseller: Bambach Saddle Seat Standard	Black	
Bambach Cutaway, genuine leather	Black	B204051
Bambach Cutaway, med. grade vinyl	Black	B203001

Genuine leather

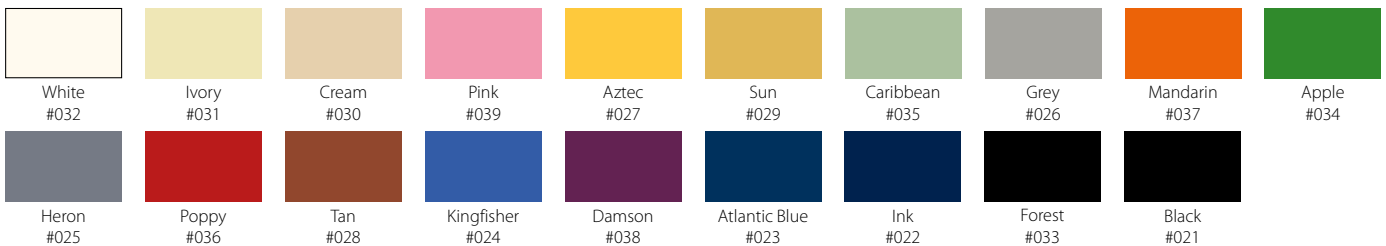

Medical Grade Vinyl (soft, abrasion resistant, disinfectable)

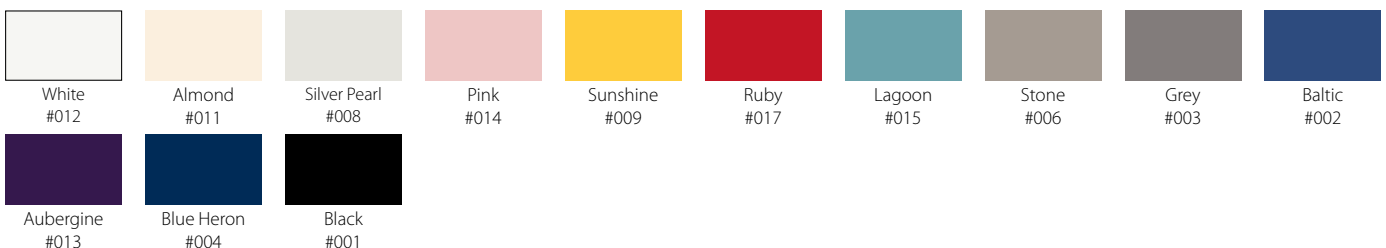



POSTURE matters:

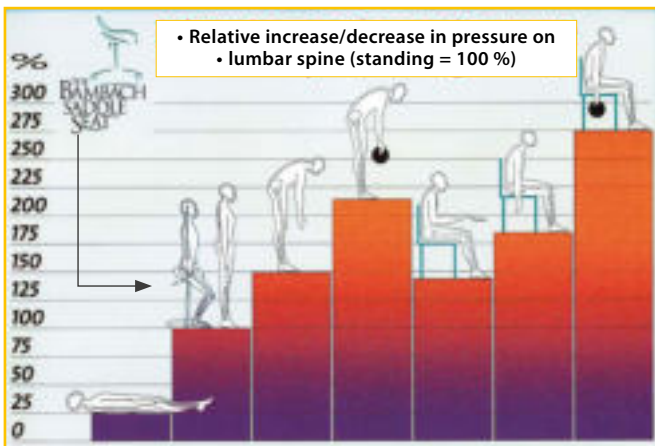
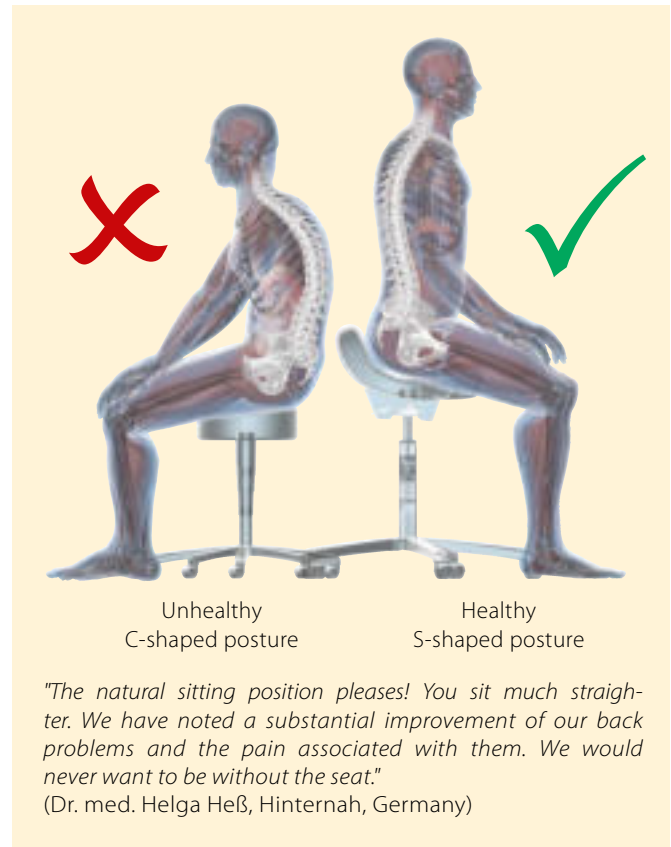

THE PROBLEM

Conventional seats force the spine into an unhealthy "C" shape. This unnatural posture increases the pressure on your spinal discs to an alarming extent, which can result in many problems, mainly in combination with pain in the back, neck, arms, hands or shoulders.

THE SOLUTION

Thanks to its patented back curvature, the Bambach Saddle Seat is the only seat that ideally supports your pelvis, allowing your spine to keep its natural "S" shape. While this avoids a poor sitting posture, you benefit from a natural, healthy posture.

Small

- Particularly popular with people with a small frame

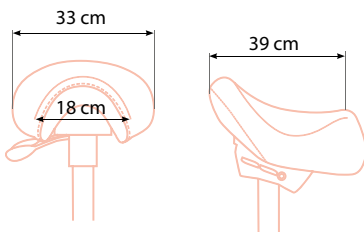

Large

- Particularly popular with people of a larger build

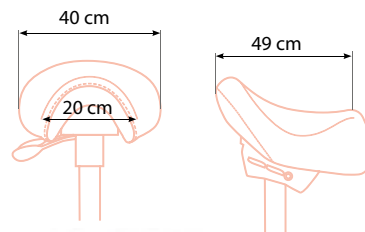

Article(s)	Color	REF
Bambach Small, genuine leather	Black	B205051
Bambach Large, genuine leather	Black	B207051

Please consider your body size when placing an order.
Height of gaslifts: S up to 1.60 m M up to 1.90 m L over 1.90 m



Bambach® Foot height adjuster

Seat particularly for operation theatres

- Easy seat height adjustment without using your hands
- Flexible and quick position change
- Ideal for surgery or prolonged treatment
- For large, medium and small gas lift heights

Article(s)	Content(s)	REF
Foot height adjuster large	1 pc.	BSTE-2015
Foot height adjuster medium	1 pc.	BSTE-2014
Foot height adjuster small	1 pc.	BSTE-2013

Additional accessories:

Leather Care Oil	50 ml	554 304
------------------	-------	---------

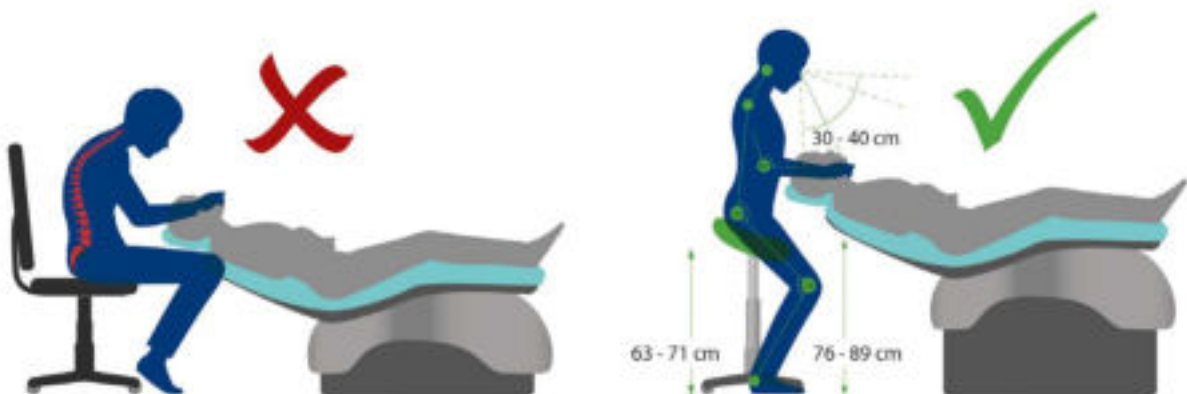



Bambach® Backrest Smart

- Fully disinfectable
- Height adjustable
- Dimensions 22 x 15 cm



Article(s)

Bambach Backrest Smart
Bambach Backrest Large

REF

BBKR-1001
BBKR-3051

Bambach® Armrest Smart

Relief during longer treatments

- Perfect for endodontics and dental surgery
- Relieves tension in the shoulder muscles
- Swivel-mounted armrest
- Length 55 cm
- Available in black vinyl only



Article(s)

Bambach Armrest Smart, mounted on the right
Bambach Armrest Smart, mounted on the left

REF

BARM-1901
BARM-3901

Bambach® Armrest

Relief during longer treatments

- Ideal for longer treatments such as endodontics and surgeries
- Relief for the shoulder muscles
- Can be swiveled and retrofitted
- In two versions:
- Armrest short (Length 30 cm)

Armrest long (Length 55 cm)



Article(s)

Armrest long, Penuine leather black, 55 cm (right)
Armrest long, genuine leather black, 55 cm (left)
Armrest short, genuine leather black, 30 cm (right)
Armrest short, genuine leather black, 30 cm (left)

REF

BARM-1051
BARM-3051
BARM-2051
BARM-4051

Bambach® Armrest Microscope

With three movable arm axes

- Armrest freely movable in width and length (free-swinging)
- Height adjustable (fixed)
- Relieves shoulder, neck and arms



Article(s)

Bambach Armrest Microscope

REF

BARM-6000

INDEX PRODUCTS

A irsonic Absorbo Box	57	Endo N2	46	Mirafloss Big	34 / 72	R eflect-Rhod	25
Airsonic Absorbo Box II	57	F it-Kofferdam Clamp Board	40 / 44	Mirafloss Implant	72	Reso-Pac	17
Airsonic Adapters	56	Fit-Kofferdam Clamp Forceps	41	Mirafluor C	69	Rotoprox	35
Airsonic Mini Sandblaster	57	Fit-Kofferdam Clamps	42 – 44	mirafluor chx	68	S afety-Box	15
Algilock	10	Fit-Kofferdam Folding Frame	41	mirafluor-gel	36	Salibag	30
Algilock Cleaner Plus	11	Fit-Kofferdam –Latex	41	Mirafluor Kids	69	SOS Zahnbox	64
Algilock Perforated	10	Fit-Kofferdam Perforating Template	40	Mirafluor-Tray	36	Spandex	23
Algiloid	11	Fit-Kofferdam Punch	41	Mirafluorid	36	Spandex-Vertical	23
Algimix	58	Fit-Kofferdam Starter Kit I	40	Mirahold	23	Speed Labolight	56
Alminax Rite-Bite	84	Fit-Kofferdam Starter Kit II	40	Mirahold-Block	23	Speedo-Clean	59
Alminax and Alminax Rite-Bite	84	Fit-Kofferdam Steel Frame	41	Miraject	12 – 15	Steri-Suc-Tube	38
Amalgam Well	48	Fit-N-Fix	21	Miramask FFP2	52	Study models	28 – 29
Anti-Stress Tooth	31	Fit-N-Swipe Clean	20	Miramatic Holder	15	Super-Splint	48
Apply-Tips	16	Fit-N-Swipe Dry	20	Miramatic Holder Plus	15	Swe-Flex	39
AQUAMED Chewing Gum	71	Flexbrush	53	Mirapont	85	T ong-Clin De Luxe	72
AQUAMED Gel	71	Funny Animals	73	Mirapont Agent Plus	82	Toothbrushing Model	29
AQUAMED Lozenges	71	G apSeal	18	Mirapont Silifit	82	Tooth Coin Bank	81
AQUAMED Spray	71	Glas Bead Heater	61	Mirapor	83	Twin-Pipette	16
AQUAMED Strips	71	Gript	49	Mirapost	46	V ariator-Kit	25
Artiholder	47	H ager iSpec		mirasensitive hap+	69	X YLIMED	63
Astro Clean	53	Cleaning wipes for glasses	52	Mirasensitive Pen hap+	68	XyliPOP	63
B ambach	86 – 90	Hager iSpec Fit OTG	51	Mirasuc Adapter	39	Xylitol Chewing Gum	62
BD-Steribox	27	Hager iSpec Laser safety glasses	52	Mirasuc Brush	38	Xylitol Drops	62
Bio Apply-Tips	5	halitosis spray	70	Mirasucto	39	Z ahnpick 2in1	66
Bio Bowl	6	Happy Morning	33 / 67	Miratoi	78 – 81		
Bio Cup	6	Happy Morning Bamboo	4 / 67	Mirator 2000E	58		
Bio Dapp	5	Happy Morning De Luxe	67	Miratray	9		
Bio Dento-Box	4	Happy Morning Travel Kit	67	Miratray 3 in 1	8		
Bio Keyboard Sleeves	5	Happy Morning Xylitol	67	Miratray Implant	8		
Bio Miratray	7	hf Bipolar-Forceps	56	Miratray-Mini	9		
Bio Miratray -Mini	7	hf Electrodes	55	Miratray Partiell	9		
Bio Miratray Partiell	7	hf Surg BiPo	54	Miratray Spray	10		
Bio Mix Mixing Pad	4	hf Surg Plus	54	Mirawet	83		
Bio Mouse Sleeves	5	hf Surg Smart	54	Mirawhite gelée	70		
Bio Sensor Sleeves	5 / 30	hf Surg Touch	54	Mirawhite shine	69		
Bio Towel	6	H&W Classic	51	Mirodent	24		
Bio Trays	4	H&W Featherlight	51	Myzotect-Tincture	17		
Bravo Portable II	59	H&W Super Fit UV (OTG)	51	N on-Stick	82		
Bravo Portable II Plus	59	I nfant-O-Brush	73	O cclu Spray Plus	11 / 22 / 82		
Brillant	24	Integra Cart Attachment Tray	61	Orange Solvent	53		
Brillant Anti-Fog	24	Integra Cart De Luxe II	60	Orbatec Prophy	85		
Brillant Kids	24	Integra Cart Smart	60	OXYSAFE Active+F	70		
C arebrush Junior Toothbrush	74	I-Prox L	65	OXYSAFE Professional	19		
Carebrush Kids Toothbrush	74	I-Prox P	66	OXYSAFE PRO2	70		
Carebrush ortho	74	K id's Brush	73	P aroguard	33 / 68		
Carebrush supersoft	74	L iftbox	27	Pelotte-Aspirator / Pelotte Plus	39		
Carebrush white	74	M ara Expert	76 – 77	Pelotte Bio	7 / 39		
CC-Shield	50	Matrix-Spanner	47	Pic-Brush Intro Kit	65		
Chiru-Cleaner	38	McTooth Mirror	28	Pic-Brush Minis	66		
Chirurgo-Suc I	38	Membranbox	25	Pic-Brush Replacement Brushes	65		
Clip-Clap Strainer RS	27	Mira-2-Ton	32 / 64	Pic-Brush Set	65		
Cold-Bag	22	Mirabrush	16	Pick up Stick	16		
Comfi-Tips	38	Miracast	84	Plaque Agent	68		
Compo Blitz Polierer	49	Mira Clean	33	Plaque Check	64		
Corund SC	84	Miraclean-Implant Black	47	Praxipolish Plus	53		
Cotton-Clip	21	Mira-Clin hap	34	Praxipol PS II	58		
Cottoroll	21	Mira-Clin P	34	Prophy-Angles	35		
Crown Click De Luxe	49	Miraclip	21	Prophy-Brush	35		
Cup Dispenser	6	Miracold Plus	22	Prophy-Cup	35		
D elject	48	miradent Hourglass	75	Protectoray	31		
Dento-Box I	75	Miradont-Gel	36	Protho Box	75		
Dento-Box I + II	26	Mira-Duo	28	Protho Box home	26		
Dipol	83	Mirafloss	72	Protho Brush De Luxe	75		
Dosing Bottle	27			Protho Clean	22 / 82		
E mmenix Film Holder	31			Proto-Cam	50		
Emmenix Flap	30			Proto-Cam Smart	50		
				Putzi-Tiere	78		

A world of innovative dentistry



facebook

YouTube

Instagram



Häger & Werken GmbH & Co. KG
Ackerstraße 1, DE - 47269 Duisburg
Tel.: +49 (203) 99269-0
Fax: +49 (203) 299283
E-Mail: info@hagerwerken.de
Internet: www.hagerwerken.de
General Manager: Patrick Häger



Häger Worldwide, Inc.
441 19TH Street SE
Hickory N.C. 28602, USA
Tel.: +001 (828) 624-3300
Fax: +001 (828) 624-3303
E-Mail: contact@hagerworldwide.com
Internet: www.hagerworldwide.com
General Manager: Patrick Rouillard



Häger Australia Pty Ltd
Level6, Wyoming*
175 Macquarie Street
Sydney NSW 2000



Häger Asia
Unit05 7/F, Tower B
New Trade Plaza
6 On Ping Street, Shatin
N.T. Hong Kong



TOO_HÄGER EURASIA*
„Dostyk Residence“
Mitina str., bldg. 4, office 904
Almaty, Kazalstan
Tel.: +7 777 031 0291
Email: o.seifert@hagerwerken.de
General Manager: Olga Seifert